New Corrosive Gas Purifier Offers Improved Moisture Performance and Removal of Volatile Metal Complexes

***Carrie Wyse, T. Watanabe,
D. Fraenkel, R. Torres, V. Houlding***

***Matheson Tri-Gas
Longmont, CO***

Outline

- **Critical contaminants in corrosive systems**
- **Effects of contaminants on process**
- **Purifier Technology**
- **Performance of new purifier**
- **Benefits of using new purifier**
- **Summary**

Critical Contaminants and Sources

- **Moisture**
 - **Source gas and container**
 - **Distribution system**
 - **Cylinder changeouts**
- **Metals**
 - **Source gas and container**
 - **Corrosion (particulates, volatiles)**
 - **Shedding from mechanical components**

Impact of Critical Contaminants

- **Moisture**

- oxygenated species cause haze which affects resistivity (Si epi, Si-Ge epi)
- degradation of distribution system due to corrosion

- **Metals**

- highly mobile in semiconductor lattice
 - can be decreased by removing moisture
 - particulates can be removed by particle filter
 - volatiles cannot be removed by particle filter

H₂O Levels in Source Gas

Gas Phase Moisture as a Function of HCl Remaining in the Tonner at 70°F, Without Purification

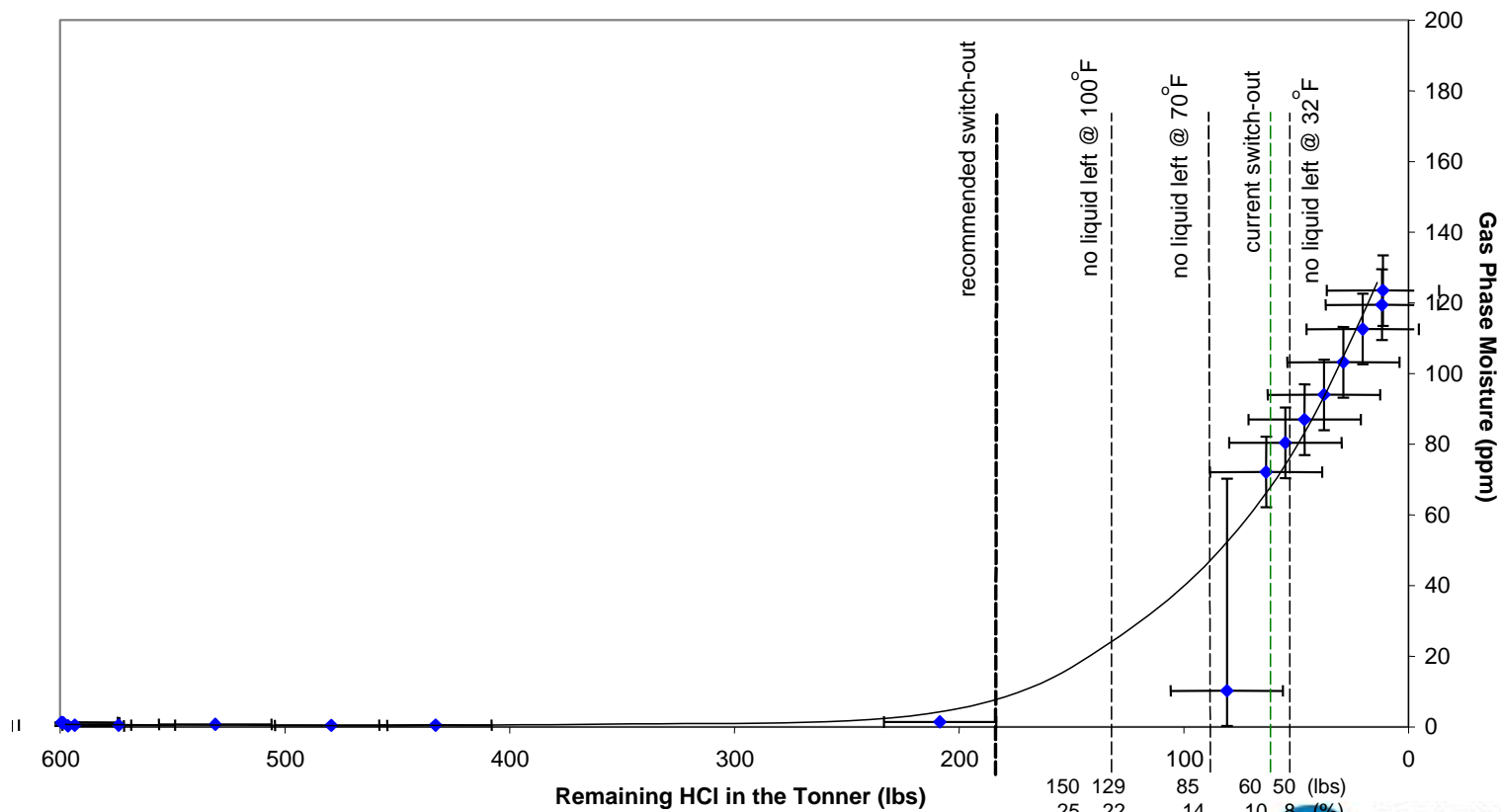

Metal Specifications for Semiconductor Grade HCl

(ppb)

Vendor	Fe	Ni	Cu	Cr	Total Metals
A	500	100	100	400	<1000
B	500	-	-	-	<1000
C	500	100	100	100	-

Note: includes particulates and volatiles

Piping Composition (%)

Material	C	Co	Cr	Cu	Fe	Ni	Mn	Mo
Monel alloy	0.3 max	*	0	31.0	2.5	*	2.0	0
SS 316L alloy	0.03 max	0	17.0	0	68.5	12.0	0	2.5
C-22 alloy	0.010 max	2.5	22	0	3	55.5	0.5	13

* minimum 63% Ni + Co

Vapor Pressures of Metal Chlorides

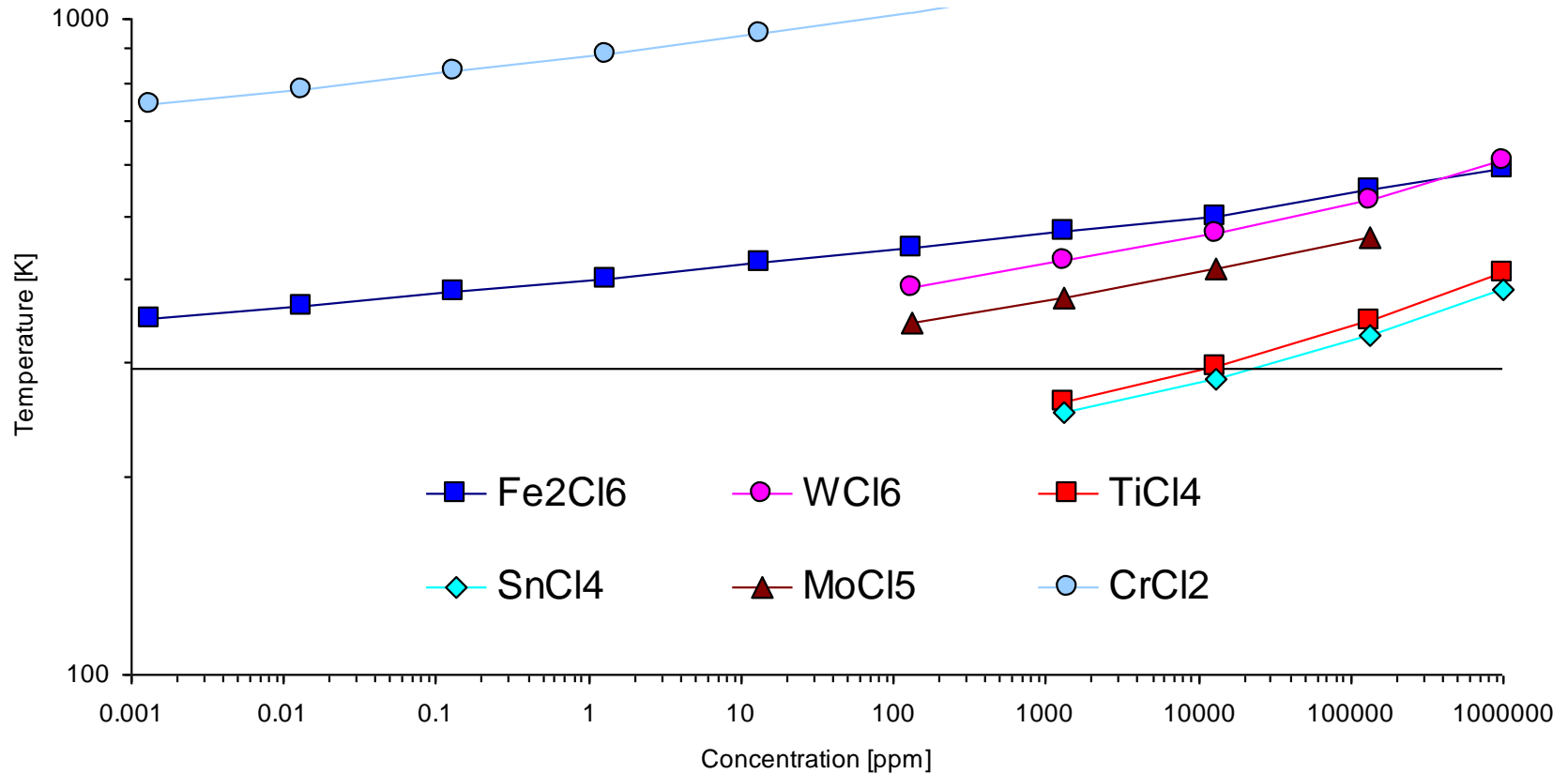

Preliminary Indication of Volatiles

	Fe (ppb)	Mo (ppb)	Ni (ppb)	Cr (ppb)
High Pressure HCl				
Short Term (2 days) (through 0.003 μm filter)	819.4	27.3	226.5	1.09
Long Term (2 mo.) (through 0.003 μm filter)	2492.8	74.5	457.0	714.9
Experiment Control	191	4.6	30.3	45.9

Nanochem MTX™ Technology

- **Robust inorganic material compatible with high pressure corrosive gases**
- **Designed to remove volatile metal species**
- **Engineered for high moisture capacity**

Test Apparatus for Volatile Metals Efficiency

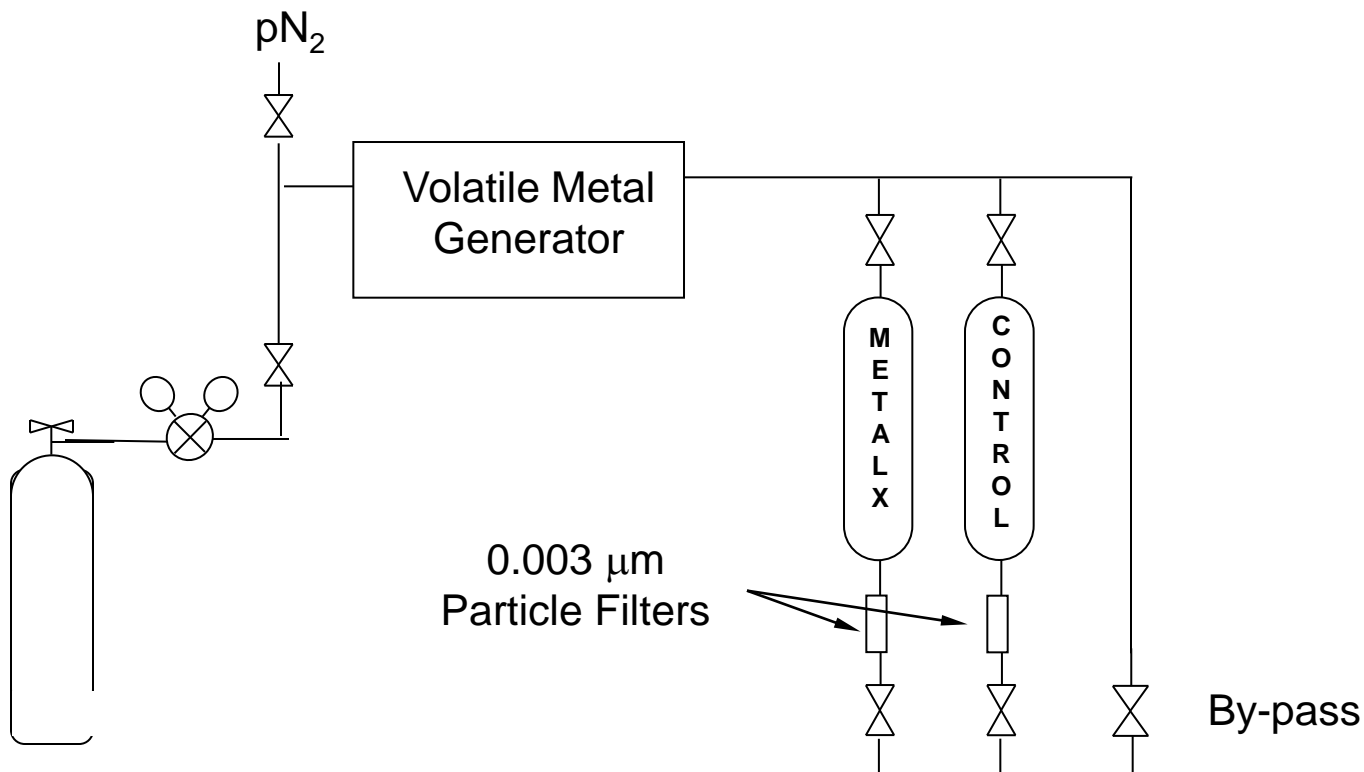

MTX™ Efficiency for Volatile Mo in HCl

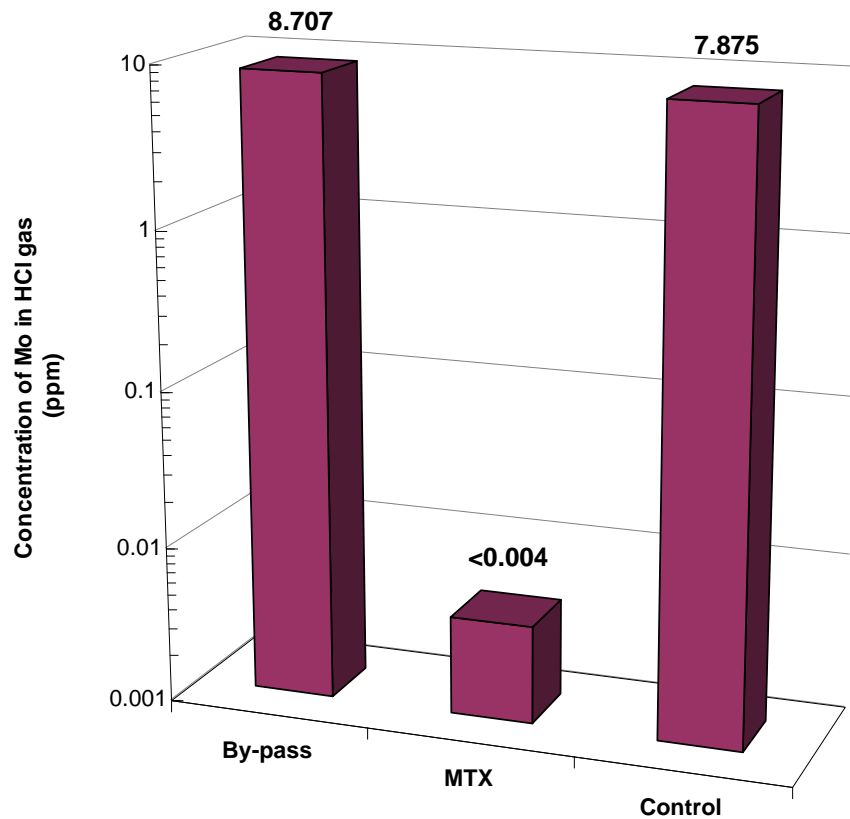

MTX™ Efficiency for Volatile Ti in HCl

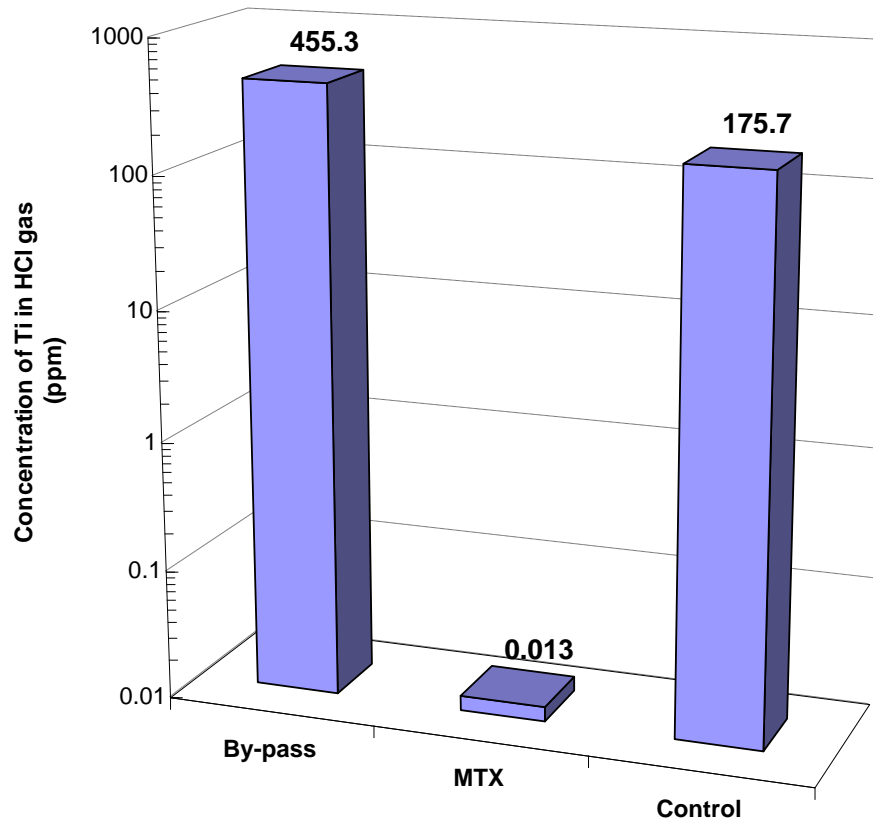

MTX™ Efficiency in HBr Service

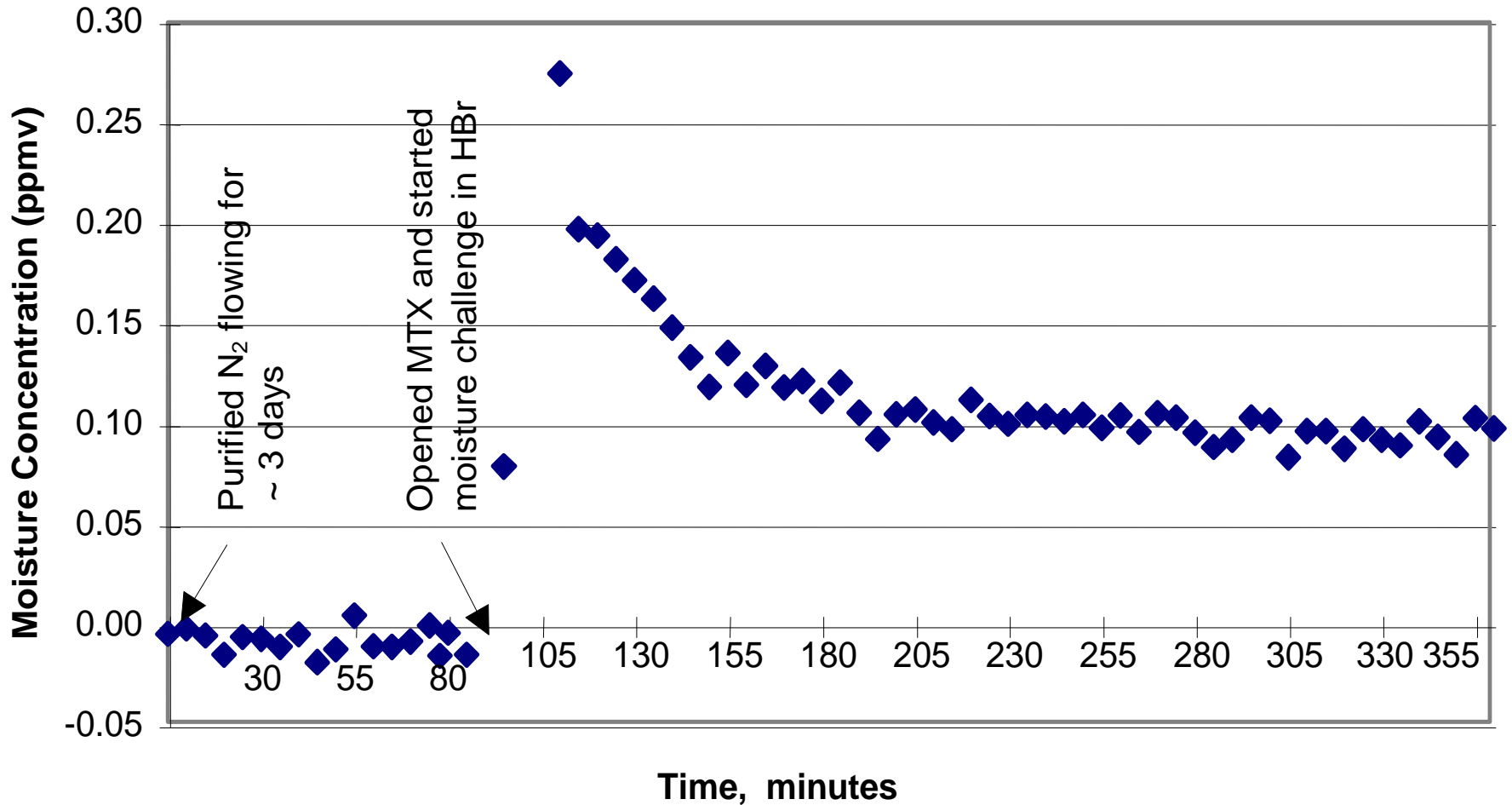

MTX™ Efficiency at High Flow

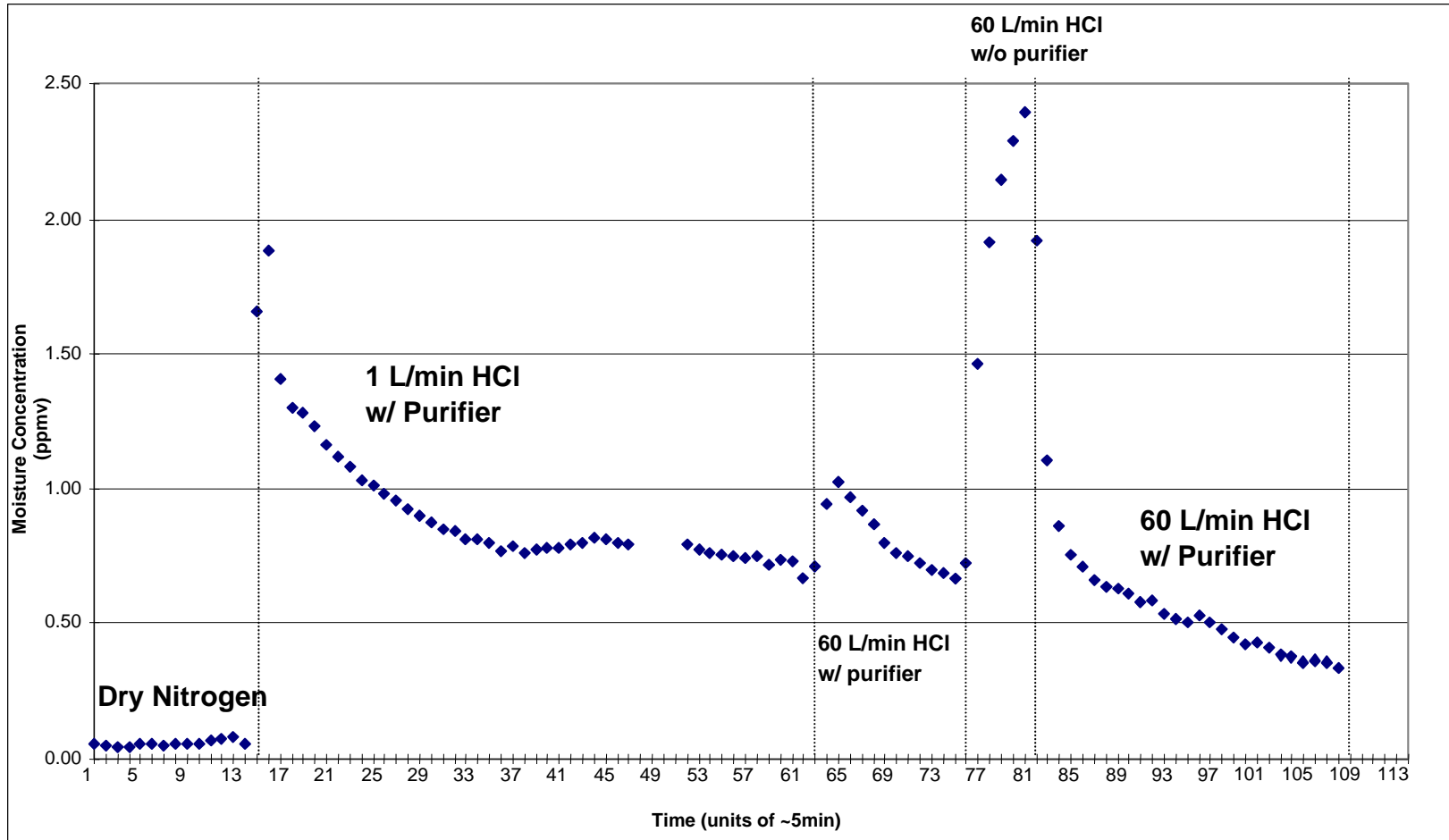

MTX™ Efficiency in N₂

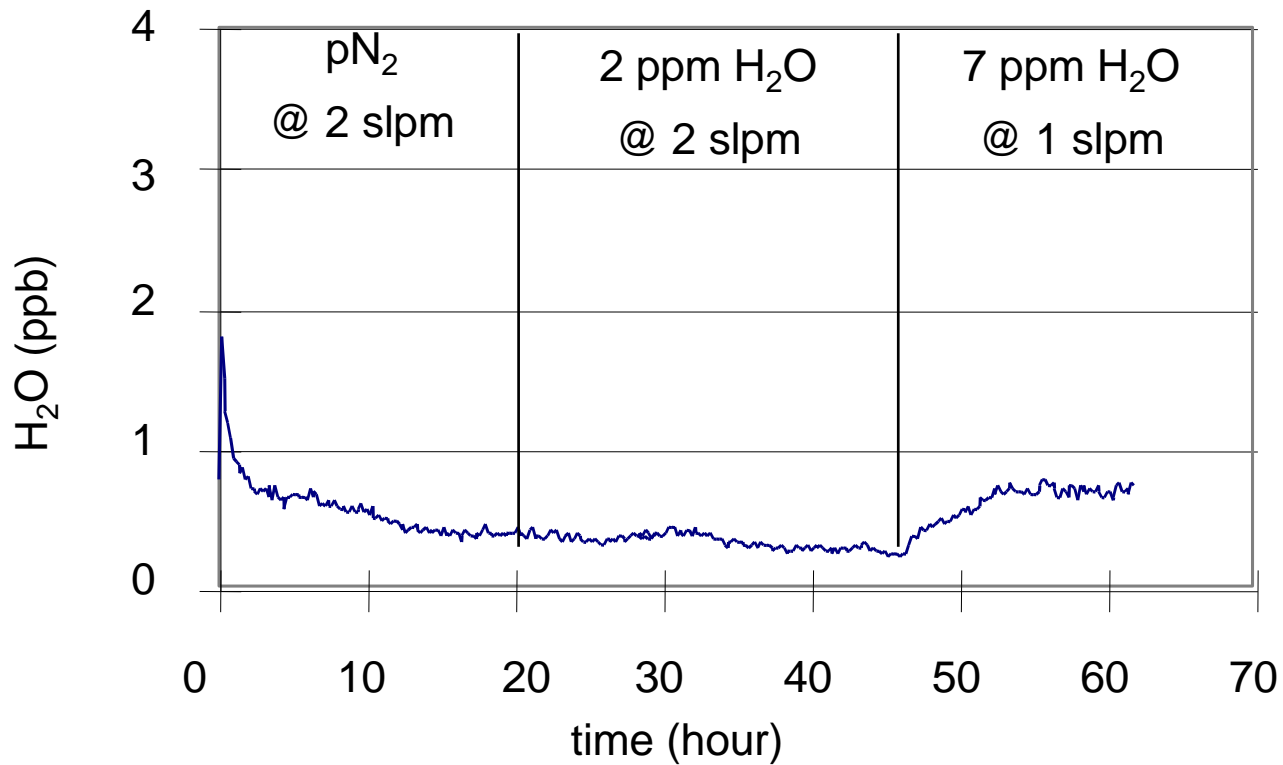

Effect of Moisture Removal on Components

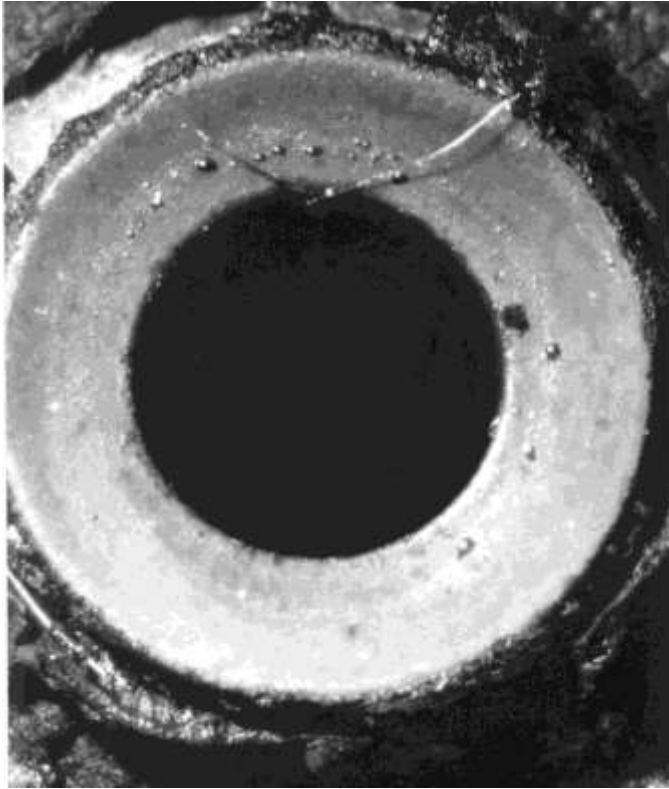

Kel-F valve seat of line valve in HBr service without Nanochem purifier, 1000 cycles



Kel-F valve seat of line valve in HBr service with Nanochem purifier, 1000 cycles

Effect of Moisture Removal on Particulates Generated in HBr

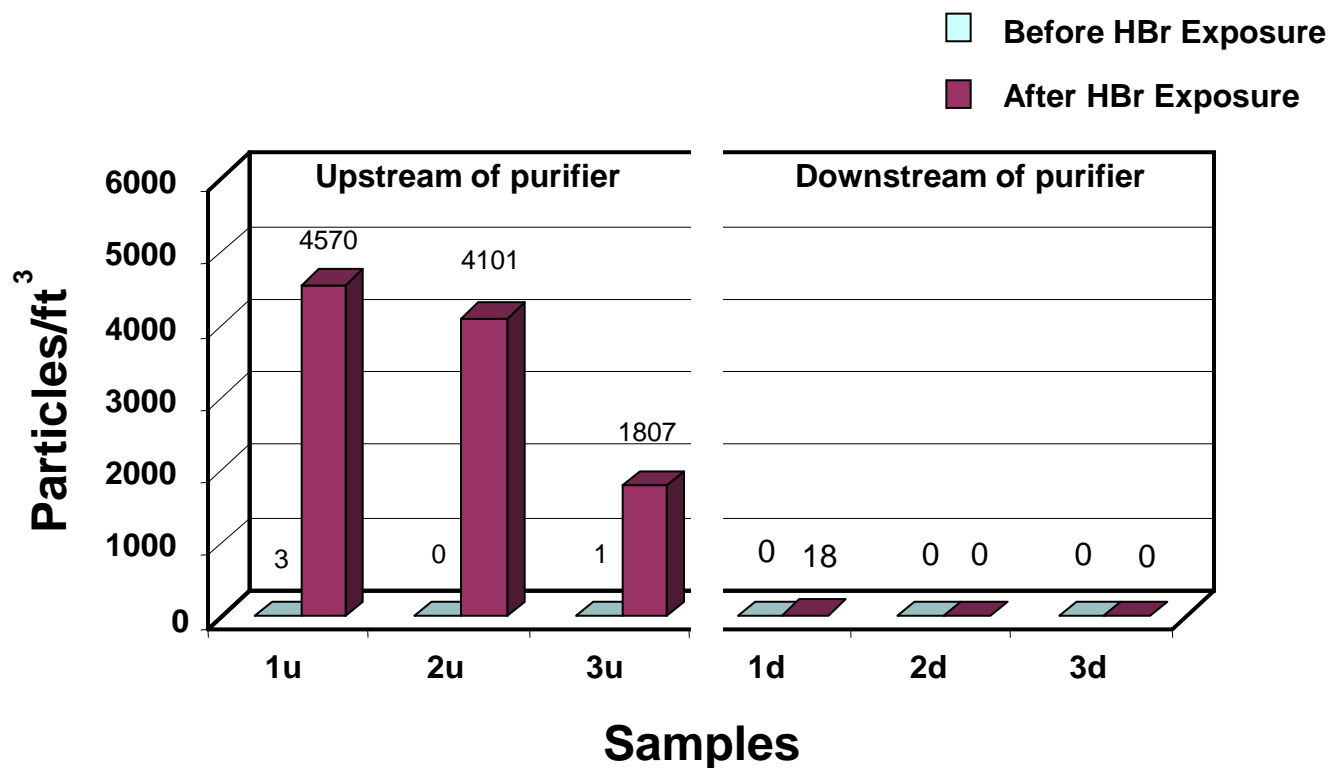

(u=upstream of purifier; d=downstream of purifier)

Effect of Particulates on Leak Rate of Valves

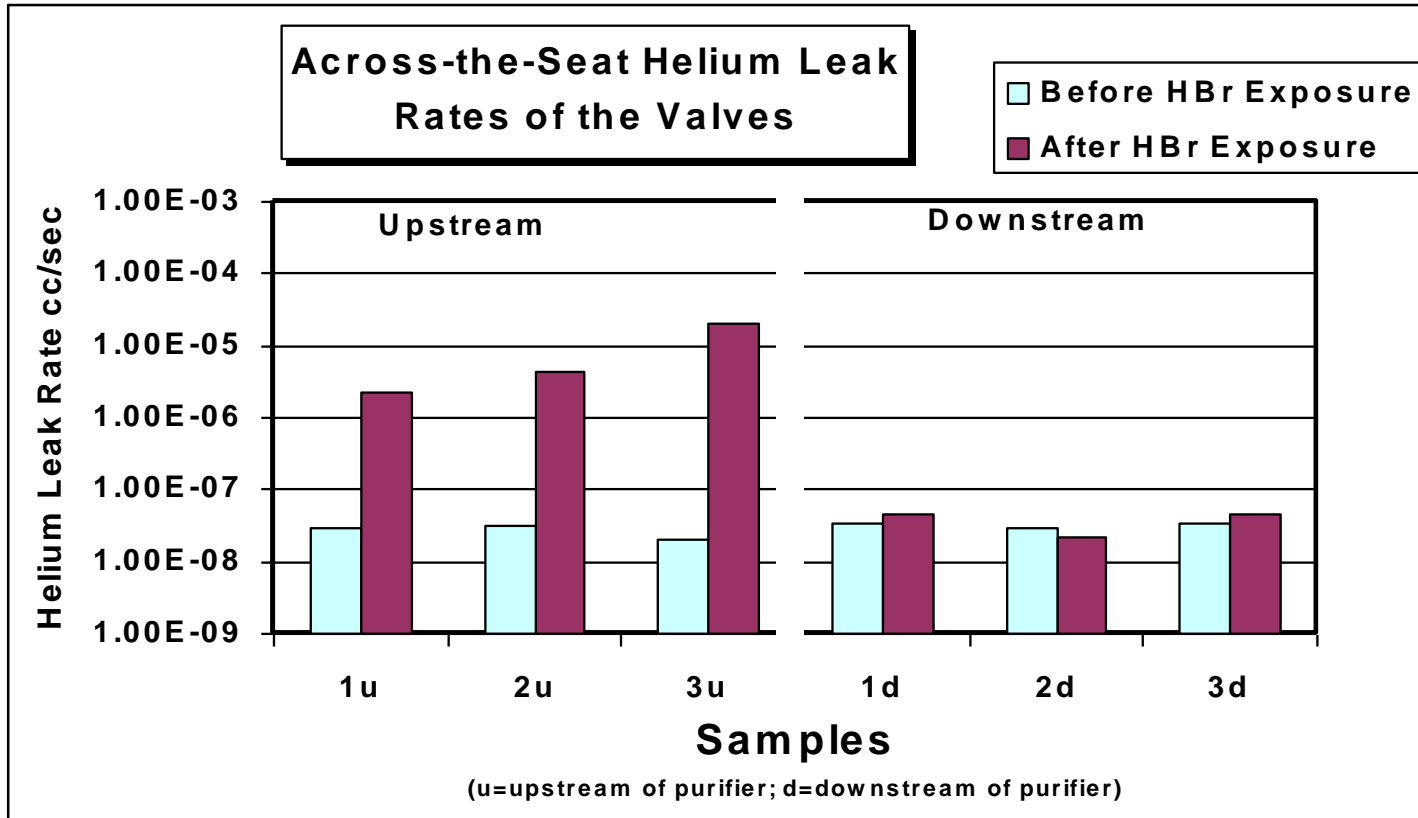

Benefits of MTX™ Purifier

- **Minimizes corrosion**
- **Reduces particulates**
- **Reduces volatile metals**
- **Prolongs life of distribution system**
- **Prevents device failure from oxygenated species, volatile metals, and particulates**

Apparatus for $\text{Fe}(\text{CO})_5$ Testing

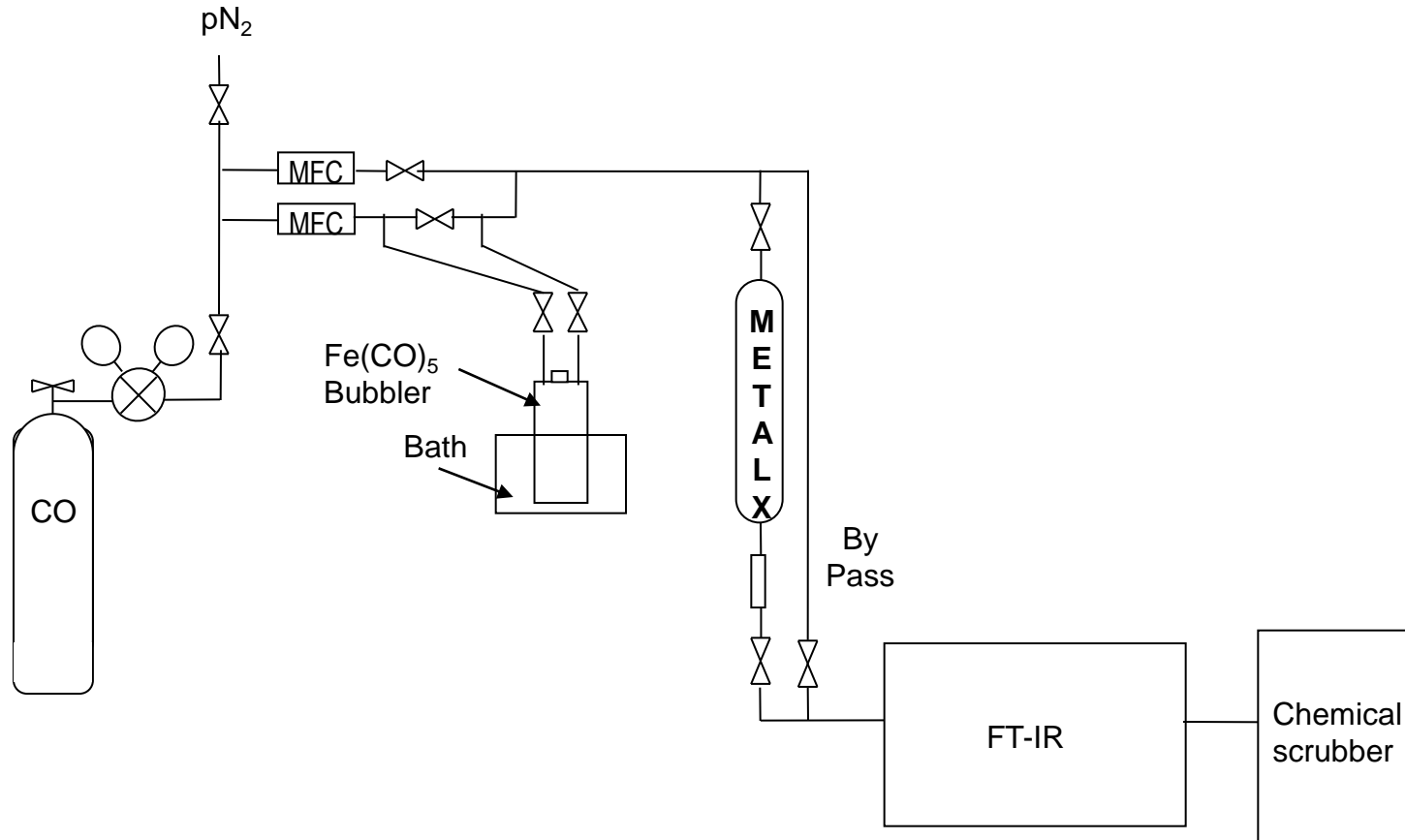

MTX™ Efficiency for Fe(CO)₅

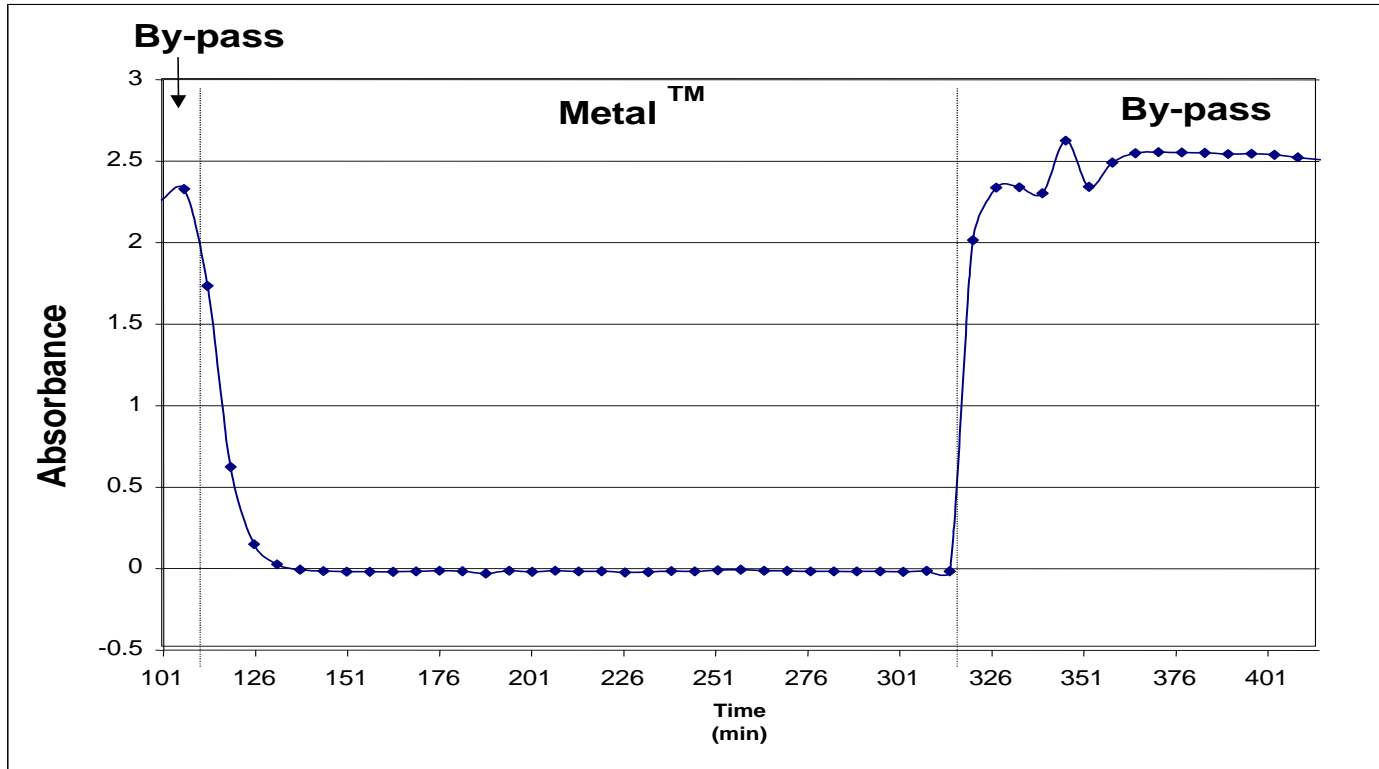

MTX™ Summary

Impurities Removed	H ₂ O Volatile Metal species (e.g. Mo, Ti, Fe) Particulates
Efficiency	<100 ppb H ₂ O in N ₂ (Lambda Scan) <1 ppb H ₂ O in N ₂ (APIMS) <4 ppb Mo in HCl (Hydrolysis/ICP-MS)
Capacity	~ 5000 kg HCl

Summary

- **Volatile metal species are electronically active contaminants that can cause device failure.**
- **Volatile metals in gas distribution systems are not removed by particle filters.**
- **Nanochem MTX is a corrosive gas purifier which removes volatile metal species, moisture and particulates in one package.**

Acknowledgements

- **Analysis Now!** for expeditious trace metal analysis of hydrolysis samples.
- **Diede Precision Welding, Inc.** for welding and assembly of manifold.