

# Safe Handling of Compressed Gases in the Laboratory and Plant

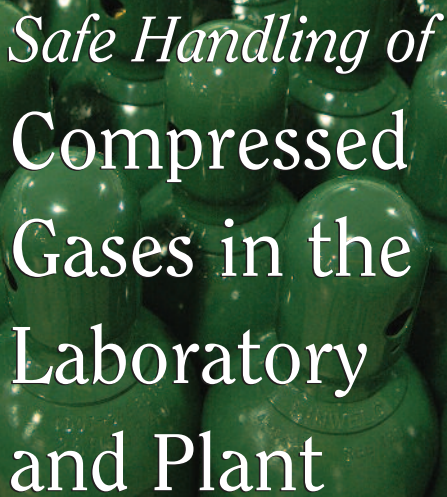

**MATHESON**

ask. . .The Gas Professionals™



# *Safe Handling of* Compressed Gases in the Laboratory and Plant

Before we are allowed to drive a car, most states require proof of our ability to drive. To become a proficient and safe driver, one must have skill, judgment, and driver education. We do not always consider that we are performing a hazardous operation by driving a car; yet the fact remains that many people are killed or hurt every day as a result of carelessness in handling this machine. Although the safety record of the compressed gas industry is excellent, the questions raised by the users of gas products, and the accidents involving these same users, show that many of them have neither learned nor applied the safety measures that would earn them their “license” for handling compressed gas. When handled by personnel who are properly trained and aware of the potential hazards, compressed gases are as safe to work with as most of the ordinary chemical liquids and solids normally handled on a routine basis in any laboratory or plant.

A compressed gas is defined by the Department of Transportation (DOT) as “any material or mixture which exerts in the packaging an absolute pressure of 280 kPa (40.6 psia) or greater at 20°C (68°F).”

## Hazards

---

The handling of compressed gases must be considered more hazardous than the handling of liquid and solid materials because of the following properties unique to compressed gases: pressure, low flash points for flammable gases, low boiling points, and no visual and/or odor detection of many hazardous gases. Hazards may arise as a result of equipment failure and leakage from systems that are not pressure-tight. Also, improper pressure control may cause over pressurization of a process component, or unsafe reaction rates due to poor flow control. Diffusion of leaking gases may cause rapid contamination of the atmosphere, giving rise to toxicity, anesthetic effects, asphyxiation, and rapid formation of explosive concentrations of flammable gases. The flash point of a flammable gas under pressure is always lower than ambient or room temperature. Leaking gas can therefore rapidly form an explosive mixture with air.

Low-boiling-point materials can cause frostbite on contact with living tissue. This is common among the cryogenic liquids such as nitrogen and oxygen, but it also can result from contact of the liquid phase of liquefied gases such as carbon dioxide, fluorocarbons, and propylene. Some compressed gases are similar to other chemicals in that they are corrosive, irritating, and highly reactive.

The procedures adopted for the safe handling of compressed gases are mainly centered on containment of the material, to prevent its escape to the atmosphere, and proper control of pressure and flow. All rules and regulations are directed toward these ends. Emergency procedures are usually only necessary because a basic rule of handling has been broken. It is far better to observe the rules and avoid the need for emergency measures. A listing of some common violations of basic rules for handling compressed gases is given in Table 1.

Table 1

## Common OSHA Violations Involving Compressed Gas

1. Unsecured cylinders
2. Cylinders stored without protective caps
3. Noncompatible gases (such as hydrogen and oxygen) stored together
4. Cylinder valves open when cylinder is not in use (an attached regulator with a closed discharge valve is not sufficient)
5. Fire extinguishers not present during welding, burning, or brazing operations
6. No safety showers and eyewash fountains where corrosive gases are used
7. No gas masks and/or self-contained breathing apparatus conveniently located near areas where toxic gases are used or stored

## General Precautions

Some general precautions for handling, storing, and using compressed gases follow.<sup>2,3,4</sup>

1. Never drop cylinders or permit them to strike each other violently.
2. Cylinders may be stored in the open, but should be protected from the ground beneath to prevent rusting. Cylinders may be stored in the sun, except in localities where extreme temperatures prevail; in the case of certain gases, the supplier's recommendation for shading should be observed. If ice or snow accumulates on a cylinder, thaw at room temperature.
3. The valve-protection cap should be left on each cylinder until it has been secured against a wall or bench, or placed in a cylinder stand, and is ready to be used.
4. Avoid dragging, rolling, or sliding cylinders, even for a short distance. They should be moved by using a suitable hand truck.
5. Never tamper with pressure relief devices in valves or cylinders.
6. Do not store full and empty cylinders together.
7. Do not have full and empty cylinders connected to the same manifold. Reverse flow can occur when an empty cylinder is attached to a pressurized system.
8. No part of a cylinder should be subjected to a temperature higher than 125°F. A flame should never be permitted to come in contact with any part of a compressed gas cylinder.
9. Cylinders should not be subjected to artificially created low temperatures (-40°F or lower), since many types of steel will lose their ductility and impact strength at low temperatures. Special stainless steel cylinders are available for low temperature use.
10. Do not place cylinders where they may become part of an electric circuit. When electric arc-welding, precautions must be taken to prevent striking an arc against a cylinder.
11. Bond and ground all cylinders, lines, and equipment used with flammable compressed gases.
12. Use compressed gases only in a well-ventilated area. Toxic, flammable, and corrosive gases should be carefully handled in a hood. Proper containment systems should be used and minimum quantities of these products should be kept on-site.
13. Cylinders should be used in rotation as received from the supplier. Storage areas should be set up to permit proper inventory rotation.

14. When discharging gas into a liquid, a trap or suitable check valve should be used to prevent liquid from getting back into the cylinder or regulator.
15. When using compressed gases, wear appropriate protective equipment, such as safety goggles or face shield, rubber gloves, and safety shoes. Well-ventilated barricades should be used in extremely hazardous operations, such as in the handling of fluorine. Gas masks should be kept available for immediate use when working with toxic gases. These masks should be placed in convenient locations in areas not likely to become contaminated, and should be approved by the U.S. Bureau of Mines for the service intended. Those involved in the handling of compressed gases should become familiar with the proper application and limitations of the various types of masks and respiration aids available.
16. When returning empty cylinders, close the valve before shipment, leaving some positive pressure in the cylinder. Replace any valve outlet and protective caps originally shipped with the cylinder. Mark or label the cylinder "empty" (or utilize standard DOT "empty" labels) and store in a designated area for return to the supplier.
17. Before using cylinders, read all label information and Safety Data Sheets (SDS) associated with the gas being used. Observe all applicable safety practices.
18. Eye baths, safety showers, gas masks, respirators, and/or resuscitators should be located nearby but out of the immediate area that is likely to become contaminated in the event of a large release of gas.
19. Fire extinguishers, preferably of the dry chemical type, should be kept close at hand and should be checked periodically to ensure their proper operation.

20. Carefully review the pressure rating of each component in the gas stream. The regulator outlet pressure may not exceed the component with the lowest pressure rating. A pressure relief valve set below the lowest component pressure is recommended.

The user of compressed gases should become familiar with the first-aid methods to be employed in cases of overexposure or burns caused by a gas. A plant doctor should be familiar with whatever further treatments may be necessary. Unnecessary delay in the treatment of a patient overcome by a toxic gas or burned by a corrosive gas could cause the patient permanent damage, and might even result in death. Authorized personnel should administer first aid; however, they should not take it upon themselves to administer medical treatments. A physician should be contacted immediately.

## Cylinders

*Figure 1* Cylinder parts and markings.

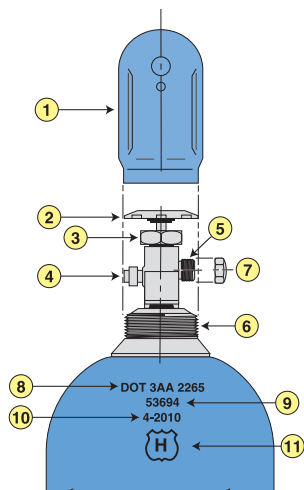

The supplier seeks to assure the safety of cylinders through adherence to regulations set forth by the Department of Transportation, and by supplying cylinders with specific valves, labels, and/or markings in accordance with recognized standards.

It is mandatory for the supplier to ship cylinders manufactured in conformance with DOT regulations and to follow DOT regulations in the testing and inspection of cylinders, the proper filling of these cylinders, and the use of pressure relief devices that are approved by the DOT.

Figure 1 shows cylinder parts and important cylinder markings. The cylinder cap (1) protects the cylinder valve. The valve handwheel (2) is used to open and close the cylinder valve. Valves are occasionally not equipped with handwheels, and require special wrenches to effect operation. The valve packing nut (3) contains a packing gland and packing around the stem. It should not be tampered with when used in conjunction with diaphragm-type valves. A pressure relief device (4) permits gas to escape if increased unsafe pressures are attained. The valve outlet connection (5) connects to pressure and/or flow-regulating equipment. Various types of connections are provided to prevent interchange of equipment for incompatible gases, usually identified by CGA (Compressed Gas Association) number; for example, CGA No. 350 is used for hydrogen service. A cylinder collar (6) holds the cylinder cap at all times, except when regulating equipment is attached to the cylinder valve. The valve outlet cap (7) protects valve threads from damage and keeps the outlet clean; it is not used universally.

Specification number (8) signifies that the cylinder conforms to the Department of Transportation specification DOT-3AA, governing materials of construction, capacities, and test procedures, and that the service pressure for which the cylinder is designed is 2265 psig at 70°F.

The cylinder serial number is indicated by (9), and (10) indicates the date (month and year: in this case, October 2010) of initial hydrostatic testing. Thereafter, hydrostatic pressure tests are performed on cylinders, for most gases, every 5 years to determine

their fitness for further use. At this time new test dates are stamped into the shoulder of the cylinder. Present regulations permit visual test in lieu of hydrostatic tests for low-pressure cylinders in certain gases free of corrosive agents; regulations also allow for hydrostatic pressure tests at 10-year intervals for cylinders in high-pressure service for certain gases. The original inspector's insignia for conducting hydrostatic and other required tests to approve the cylinder under DOT specifications is shown by (11).

---

### **Filling**

Nonliquefied gases may be filled to the service pressure marked on a cylinder. These markings will appear on the shoulder of the cylinder, i.e., DOT3AA-2265, indicating that the cylinder has been manufactured in accordance with DOT specifications 3AA, and the cylinder filling pressure is 2265 psi at 70°F. At present, DOT regulations permit a 110% filling for certain non-liquefied, non-flammable gases. Liquefied gases, on the other hand, must be filled to a filling density. This filling density represents the maximum weight of the material permitted in the cylinder, as a percentage of the water capacity of the cylinder.

Since compressed gas cylinders are handled by a number of different types of plant personnel, consider the precautions to be taken in handling from the time it is delivered until the time it is emptied and ready for return.

---

### **Receipt and Content Identification**

When a cylinder is delivered to the receiving department, it should have 1) content identification by stenciling or labels, 2) a DOT label, and 3) a valve-protection cap. Under no circumstances should the means of identification be removed from the cylinder. The valve-protection cap (Figure 1) should also remain in place until the user has secured

the cylinder and is ready to withdraw the contents. DOT labels are required for cylinders in interstate transportation. Some states require these labels for intrastate shipments also. These labels have a minimum of precautionary handling information and will classify the cylinder contents as flammable, nonflammable, poison, or corrosive.

Proper identification of cylinder content can be made by checking the cylinder shoulder label. Stenciling and/or cylinder color should never be used for positive identification. If any doubt exists as to cylinder content, contact your supplier before using the cylinder.

### **Proper Storage**

---

After cylinders are received, they should be stored in a detached and well-ventilated or open-sided building. Storage buildings or areas should be fire resistant, well ventilated, located away from sources of ignition or excessive heat, and dry. Such areas should be prominently posted with the names of the gases being stored. Indoor storage areas should not be located near boilers, steam or hot water pipes, or any sources of ignition. Outdoor storage areas should have the proper drainage and should be protected from the direct rays of the sun in localities where high temperatures prevail. Subsurface storage areas should be avoided. Cylinders should be protected against tampering by unauthorized personnel.

Cylinders should be stored in accordance with CGA Pamphlet P-1. Where gases of different types are stored at the same location, cylinders should be grouped by types of gas, the groups arranged to take into account the gases contained -- for example, flammable gases should not be stored near oxidizing gases. Storage in a laboratory should be confined to only those cylinders in use. In all cases, storage areas should comply with federal, state, and local

requirements as well as with the standards of the Compressed Gas Association and the National Fire Protection Association.<sup>2,4</sup>

### **Transportation**

---

When cylinders are being moved from a storage area into the laboratory or plant, the valve-protection cap should be left in place. The cylinder should then be transported by means of a suitable hand truck (Figure 2). Such a hand truck should be provided with a chain or belt for securing the cylinder on the truck. If a large number of cylinders must be moved from one area to another, a power device, such as a fork truck equipped with a special container and provided with some means of securing the cylinder, can be used. Do not lift cylinders by the cap. Avoid dragging or sliding cylinders. Use hand trucks even for short distances.



*Figure 2 – Models 6114A and 6214A  
Cylinder Hand Trucks*

### **Securing Cylinder Prior to Use**

---

When the cylinder has reached its destination in the laboratory or plant, it should be secured to a wall, a bench, or some other firm support, or placed in a cylinder stand, rack or cabinet (Figures 3-9). An ordinary chain or belt of the type commonly available from your gas supplier can be used. Once the cylinder has been secured, the cap may be removed, exposing the valve. The number of cylinders in a laboratory should be limited to minimize the fire and toxicity hazards.



Figure 3 – Model 708 Bench Type Cylinder Holder



Figure 4 – Model 710 Wall Mounted Cylinder Holder



Figure 5 – Model 700 and 701 Small Cylinder Stands

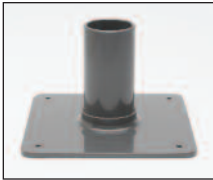

Figure 6 – Model 704-B Lecture Bottle Holder for Bench Use



Figure 7 – Model 704-W Lecture Bottle Holder for Wall Mounting



Figure 8 – Model 1191 Lecture Bottle Storage Cabinet



Figure 9 – Model 6530 Series Cylinder Storage Racks

## Pressure Relief Devices

Pressure relief devices are incorporated in most DOT compressed gas cylinders, except those containing poison or toxic gas, where the risk of exposure to fumes is considered more hazardous than that of a potential cylinder failure. Pressure relief devices are incorporated in the cylinder valve, in plugs in the cylinder itself, or both. In certain types of gas service, and in many cylinders over a particular length (usually 65”), two pressure relief devices may be required, one at each end of the cylinder.

Pressure relief devices are required to meet DOT regulations.<sup>5</sup> These pressure relief devices are of four basic types:

1. Spring-loaded pressure relief valve, used mostly for low-pressure, liquefied, flammable gases.
2. Frangible disc, used mostly for high-pressure cylinders.
3. Frangible disc backed up by a fusible metal for non-liquefied, flammable gases and some liquefied gases such as hydrogen, carbon monoxide, and hydrogen chloride.
4. Fusible metal for certain toxic, corrosive gases such as chlorine and sulfur dioxide.

The spring-loaded pressure relief valve consists of a spring-loaded seat that opens to relieve excessively high pressures and then closes when the pressure returns to a safe value.

The frangible disc will burst at a pressure that is above the service pressure of the cylinder, but usually not higher than the test pressure for that cylinder.

The frangible disc backed up by a fusible metal will function only if there is the presence of excess pressure which causes the disc to burst, and high temperature which causes the fusible metal to melt. The release of the cylinder contents is dependent upon both pressure and temperature.

The fusible metal devices melt at excessive temperatures (either 165°F or 212°F), allowing the entire contents of the cylinder to escape.

Pressure relief devices will prevent a charged cylinder from bursting due to excessively high temperatures or pressures. However, devices 3 and 4 will not prevent a charged cylinder from bursting solely, as a result of over pressurization. A temperature in excess of the melting point of the fusible metal is required for release of the product. Since the proper functioning of cylinder pressure relief devices depends to a large extent on the proper filling of a cylinder, such filling should never be attempted by the user. Pressure relief devices may also fail to function properly if an intense flame impinging on the side wall of a cylinder weakens the metal to the point of failure before heat or pressure can cause the pressure relief device to function properly.

Finally, it must be emphasized that tampering with cylinder pressure relief devices is extremely hazardous.

## Knowing the Gas to be Handled

It is of the utmost importance that the user be well aware of those properties of a compressed gas that represent hazards (such as flammability, toxicity, chemical activity, and corrosive effects). Every attempt should be made to learn these various properties before the gas is put to use. It is sometimes difficult to determine the major hazard of any one gas, since this factor is influenced a great deal by how the gas is used. In a laboratory hood in the presence of an open flame, the flammability of carbon monoxide might well be the major hazard, whereas in a pilot-plant run using carbon monoxide as a reactant, leakage, and therefore toxicity, may represent the major hazard.

Figure 10 shows the flammability ranges of various gases.<sup>6</sup> Although the flammability

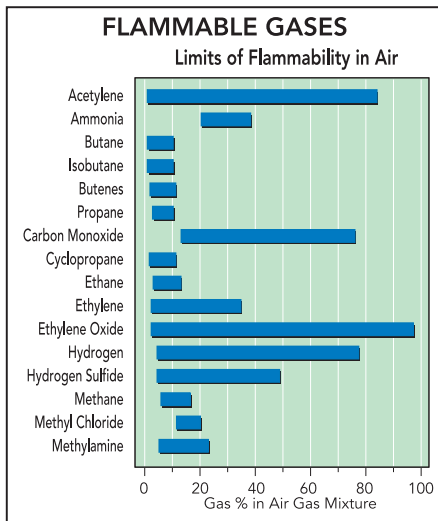

Figure 10 – Flammability Range of Gases

ranges of liquefied petroleum gases such as butane and propane are relatively short, only very small concentrations are necessary to create flammable mixtures. The flammability ranges of acetylene, carbon monoxide, ethylene oxide, hydrogen sulfide, and hydrogen are extremely long, indicating that they can form explosive mixtures with air under a wide variety of conditions.

It is important to know what materials of construction must be used with a gas to prevent failure of equipment due to corrosion, or to avoid possible formation of hazardous compounds (such as acetylides formed by the reaction of copper with acetylene or gases containing acetylene as an impurity) or the possible formation of fulminates when mercury is used in the presence of ammonia.

The hazards of toxic, flammable, and corrosive gases can be minimized by working in well-ventilated areas. Where possible, work should be done in a hood, employing cylinder sizes that will assure use of all the gas within a reasonable amount of time. Leaks should not be allowed to go unchecked. Advise the



supplier immediately of cylinder leaks that cannot be stopped by simple adjustment, such as tightening a packing nut.

## Proper Discharge of Cylinder Contents

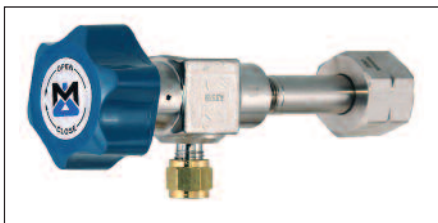

Figure 11 – Model 4351 Manual Control Valve

For controlled removal of the liquid phase of a liquefied gas, a manual control is used (Figure 11). Special liquid flow regulators are also available. It must be remembered that withdrawal of liquid must necessarily be carried out at the vapor pressure of the material. Any attempt to reduce the pressure will result in flashing of all or part of the liquid to the gas phase.

Rapid removal of the gas phase from a liquefied gas may cause the liquid to cool too rapidly, causing the pressure and flow to drop below the required level. In such cases, cylinders may be heated in a water bath with temperature controlled to no higher than 125°F. Rapid gas removal can also be effected by transferring the liquid to a heat-exchanger, where the liquid is vaporized to a gas. This method imposes no temperature limitations on the material; however, care should be taken to prevent blockage of the gas line downstream of the heat-exchanger, as this may cause excessive pressure to build up in both the heat-exchanger and the cylinder. Safety relief devices should be installed in all liquid-transfer lines to relieve sudden, dangerous hydrostatic or vapor-pressure buildups.

For nonliquefied gases, the most common



Figure 12 – Model 3120A Dual Stage High Purity Brass Regulator

device used to reduce pressure to a safe value for gas removal is a pressure regulator. This device is shown in Figure 12. It consists of a spring - (or gas-) loaded diaphragm that controls the throttling of an orifice. Delivery pressure will exactly balance the delivery pressure spring to give a relatively constant delivery pressure. Review the pressure rating of all components in the gas stream and confirm that the regulator outlet pressure does not exceed any component.

### Pressure Regulator Handling and Use

A regulator should be attached to a cylinder without forcing the threads. If the inlet of a regulator does not fit the cylinder outlet, no effort should be made to try to force the fitting. A poor fit may indicate that the regulator is not intended for use on the gas chosen.

The following procedure should be used to obtain the required delivery pressure:

1. After the regulator has been attached to the cylinder valve outlet, turn the delivery pressure-adjusting screw counterclockwise until it turns freely.
2. Open the cylinder valve slowly until the tank gauge on the regulator registers the cylinder pressure. At this point, the cylinder pressure should be checked to see if it is at the expected value. Contact your gas supplier if pressure is less than expected. (Note: Low cylinder pressure may indicate a leaking valve which can be a serious safety issue.)

3. With the flow-control valve at the regulator outlet closed, turn the delivery pressure-adjusting screw clockwise until the required delivery pressure is reached. Control of flow can be regulated by means of the valve supplied in the regulator outlet or by a supplementary valve put in a pipeline downstream from the regulator. The regulator itself should not be used as a flow control by adjusting the pressure to obtain different flow rates. This defeats the purpose of the pressure regulator, and in some cases where higher flows are obtained in this manner, the pressure setting may be in excess of the design pressure of the system.
4. After flow is established, the set delivery pressure may decrease slightly. Check to see that the delivery pressure is as desired and make any necessary adjustments.
5. Ensure that the delivery pressure does not exceed the pressure rating of any component in the gas stream.

### ***Types of Pressure Regulators***

---

The proper choice of a regulator depends on the delivery-pressure range required, the degree of accuracy of delivery pressure to be maintained, and the flow rate required. There are two basic types of pressure regulators, single-stage and double, or two-stage. The single-stage type will show a slight variation in delivery pressure as the cylinder pressure drops. It will also show a greater drop in delivery pressure than a two-stage regulator as the flow rate is increased. In addition, it will show a higher “lock up” pressure (pressure increase above the delivery set-point necessary to stop flow) than the two-stage regulator. In general, the two-stage regulator will deliver a more nearly constant pressure under more stringent operating conditions than will the single-stage regulator.

Gas purity will also need to be considered when selecting the correct regulator. Regulator design and materials of construction could adversely affect the purity of the gas being used. Choose a High Purity Regulator for applications where purity of gas is critical. For more details and information on high purity designs, reference your MATHESON Catalog or contact your specialty gas representative.

### ***Manual Flow Controls***

---

Where intermittent flow control is needed and an operator will be present at all times, a manual type of flow control may be used. This type of control (illustrated in Figure 11) is simply a valve that is operated manually to deliver the proper amount of gas. Fine flow control can be obtained, but it must be remembered that dangerous pressures can build up in a closed system or in one that becomes plugged, since no means are provided for automatic prevention of excessive pressures.

### ***Determining the Amount of Gas in a Cylinder***

---

As the content of a cylinder of nonliquefied gas is discharged, the cylinder pressure decreases by an amount proportional to the amount withdrawn. The cylinder should be considered empty while positive pressure (25 psig or greater) still remains, in order to prevent reverse flow and contamination. Failure to close the valve on an empty cylinder will allow air and moisture to be drawn into the cylinder as it “breathes” during temperature changes; an explosive mixture may build up if the gas is flammable; and an extremely corrosive condition will be created in cylinders that contain chlorine, hydrogen chloride, or other acid-forming or corrosive gases.

As the vapor phase of a liquefied gas is withdrawn from a cylinder, the cylinder pressure or vapor pressure will remain constant as long as any liquid is present.

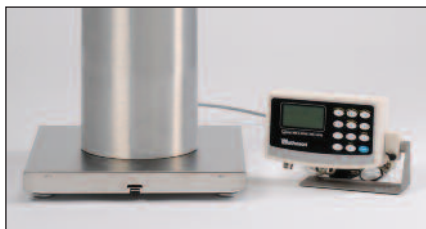

Figure 13 – Model DS-R Electronic Cylinder Scales

This condition holds true if the temperature does not vary. If, however, the material is withdrawn from the cylinder at a rapid rate, the material itself will supply the heat for vaporization, and upon subsequent cooling, the vapor pressure will be lowered. It is, therefore, impossible to determine the content of a cylinder containing a liquefied gas, except by weighing. A scale such as the one shown in Figure 13 makes this convenient. Cylinders containing liquefied gases are stamped or tagged with the tare weight in order to allow the content to be determined.

An indication of cylinder-content depletion for some high pressure liquefied gases such as carbon dioxide, ethane, and nitrous oxide can be obtained by noting the cylinder pressure. After depletion of the liquid phase, the cylinder pressure will decrease below the normal vapor pressure, as long as the contents have not been withdrawn rapidly before the cylinder pressure is noted. A cylinder containing carbon dioxide will have approximately 20% of its original content remaining after depletion of the liquid phase. As with cylinders of nonliquefied gases, cylinders containing liquefied gases should never be completely emptied, in order to prevent reverse flow and contamination of the cylinder.

## Handling Empty Cylinders

Where cylinders are considered empty, the valves should be closed. Valve-protection caps, outlet dust caps, and other

accessories shipped with the cylinder should be attached to the cylinder as received. The cylinder should be marked or labeled “empty.” Cylinders should then be placed in a proper storage area, segregated from full cylinders, to await pickup for return to the supplier.

Carelessness in the handling of an empty cylinder could result in its being mistaken for a full cylinder. Connecting an empty cylinder to a high-pressure system could cause foreign materials to back up into the cylinder, resulting in all the attendant hazards of reverse flow, and possible violent reaction within the cylinder.

## Leak Detection

Check cylinders and all connections under pressure for leaks prior to using the contents.

When using toxic gases, it is advisable that some device be used to warn of the presence of toxic concentrations.



Figure 14 - Model 8081A Toxic Gas Leak Detector

There are numerous monitoring devices available for detection of dangerous concentrations of gases in the atmosphere (Figure 14). There are also appropriate chemical procedures for detecting leaks in lines and equipment and for determining dangerous concentrations of gases in the atmosphere. The user of gases should become familiar with suitable control procedures for the determination of such dangerous concentrations. Instructions are usually supplied in the Safety Data Sheets (SDS) associated with the particular gas being used. SDS sheets can be found at [www.chemadvisor.com/MATHESON](http://www.chemadvisor.com/MATHESON)

An emergency plan can function efficiently only if a trained safety crew is educated in the proper handling of gas cylinders, with training in the procedures to be followed in cases of emergency with all the gases handled by the facility. Equipment such as self-contained gas masks must be available for handling toxic gases or for handling asphyxiating gases in close confines.

Emergencies involving flammable gases must be managed with the utmost care in order to prevent ignition. The aftermath of gross leakage is extremely important. All areas must be adequately vented before the restoration of power in cases of flammable-gas leakage. Areas contaminated by corrosive gases must be adequately vented and completely washed down to prevent subsequent degradation of delicate instruments, electrical contacts, etc.

On rare occasions, emergency action may be necessary in order to move a leaking cylinder to a location where it can vent safely, or it may have to be removed from a building and brought outdoors. In such instances, an emergency plan should be put into effect:

1. Properly warn all personnel required to evacuate a building or section of a building.
2. Shut off electrical power to prevent ignition of a leaking flammable gas.
3. Determine the shortest route to the point of gas disposal.
4. Obtain satisfactory conveyance, such as a hand truck, to move the cylinder swiftly.
5. Post the area where the cylinder is venting to prevent tampering by unauthorized personnel.

## Handling of Corrosive Gases

---

Corrosive gases should be stored for the shortest possible periods before use, preferably less than three months. Storage areas should be as dry as possible. A good supply of water should be available to handle emergency leaks. Most corrosive gases can be absorbed in water.

Corrosive gases should not be stored in areas containing instruments or other devices sensitive to corrosion. These gases should be segregated as to type, and rotated so that the oldest stock is used first. Toxic, flammable and corrosive gases should be handled carefully. Proper containment systems should be used and minimum quantities of these products should be kept on-site. Cylinders used and then put back in storage should have all appurtenances (regulators, control valves, etc.) removed from the valve outlet and should preferably be flushed with dry nitrogen or air to keep them in good working order.

When corrosive gases are being used, the cylinder valve stem should be periodically opened and closed to prevent "freezing." The valve should be closed when the cylinder is not in use. Regulators and valves should be closed when the cylinder is not in use and flushed with dry air or nitrogen after use. Such control devices should not be left on a cylinder, except when it is in frequent use. When corrosive gases are to be discharged into a liquid, a trap, check valve, or vacuum break device should always be employed to prevent dangerous reverse flow.

## Other Safety Ideas from MATHESON



Model 6103A Series Flash Arrestor

### The Use of Flash Arrestors

Whenever a flammable gas is to be used it is recommended that a simple flash arrestor be installed in the line. Flashback is the reversing of the flame such that it travels through the line back into the pressure regulator or cylinder. Most welders incorporate flash arrestors in their system.

Laboratories, however, often use gases like acetylene, one of the most hazardous, for atomic absorption instruments...and do not incorporate a flash arrestor. The same is true for other instrumentation such as flame ionization detector GC and flame photometers. Flash arrestors are easy to install in existing systems. They are available in either brass or stainless steel.

### Heavy Duty Hand Trucks

When transporting cylinders, one or two, we recommend the use of heavy duty hand trucks. The hand trucks that we propose are specifically designed to handle compressed gas cylinders and transport them safely over all types of surfaces, even gravel beds.



Model 6214A Two Cylinder Hand Truck

The wheels are designated "hi-load capacity" and there is a rigid rear carriage support which supports the weight of the cylinders to balance the truck and cylinder, so you can concentrate on steering.



Model 6114A Single Cylinder Hand Truck

A less specific truck may not encompass such features and will lack the necessary stability for cylinder transport.

### Gas Detection

Where toxic gases are in constant or intermittent use, it is recommended that some sort of toxic gas detector system is used. A continuous monitoring system based on a GC principle is frequently ideal for a plant which uses benzene or vinyl chloride all the time. If the use of toxic gas is intermittent, we recommend the MATHESON-Kitagawa Toxic Gas Detector System.

This system consists of a small, calibrated, 100cc hand pump. A tube for a specific vapor is inserted and



Kitagawa Toxic Gas Detector Tubes



Model 8014KB Toxic Gas Detector Tube System

a sample of the atmosphere is drawn through the tube by the pump. In most cases, a constant color stain is produced which varies in length according to the concentration of the vapor being measured. The system measures over 100 different materials such as ammonia, benzene, chlorine, ethylene oxide, hydrogen sulfide, etc. It is designed for operation by nontechnical personnel.

### **MATHESON Gas Cabinets**

Many industries have recognized gas cylinder cabinets as a cost effective way of protecting life and property from toxic, flammable and corrosive gases. Gas cabinets can also help the user comply with building and fire codes specified by federal, state and local agencies.



*Model 1170 Series Gas Cylinder Cabinet*

MATHESON's line of gas cabinets offers many advantages to users:

- Compliance with Article 80 of the Uniform Fire Code, OSHA and NFPA standards.
- Separate access panel and wire-reinforced safety glass viewing window provide added protection for employees working with hazardous gases in the cabinet.
- Fire sprinkler head for extra protection.
- Low-profile cylinder deck makes cylinder installation and removal easy.
- Constructed of rugged 12-gauge cold rolled steel with welded seams.
- Cabinets are fitted with u-channel supports for easy installation and adjustment of many types of gas handling systems.

### **Excess Flow Valves**

The excess flow valve is designed to shut down gas supply systems in the event of abnormal flow conditions caused by rupture, fire, open free flowing valves, etc.

The valve will automatically detect excess flow when the event occurs and will shut down the supply flow immediately so that the remaining content of the cylinder(s) does not empty into the work or storage area.



*Model 6290 Series Excess Flow Valve*

This is critical with toxic, poisonous or flammable gases but can also be important when dealing with inert gases in small, poorly ventilated areas where asphyxiation can be a potential hazard. Excess flow valves are highly effective and important safety equipment -- MATHESON recommends these devices wherever hazardous gases are being used.

## References

---

1. *Hazardous Materials Regulations of the Department of Transportation, 49CFR Parts 171-180, R. M. Graziano Tariff, issued by R.M. Graziano, Agent, 1920 "L" St. N.W., Washington, D.C. 20036*
2. *Handbook of Compressed Gases (Reinhold Publishing Corp., N.Y., 1985).*
3. *Gas Data Book (MATHESON Gas Products, East Rutherford, N.J., 1971), 6th ed.*
4. *Compressed Gases, Safe Practices Pamphlet No. 95, National Safety Council, Chicago, IL.*
5. *Pressure Relief Device Standards, Part I, Cylinders for Compressed Gases, Pamphlet S-1.1, Compressed Gas Association, Inc., Arlington, VA.*
6. *COWARD, H.F. and JONES, G.W., Limits of Flammability of Gases and Vapors, Bulletin 503, Bureau of Mines, Government Printing Office, Washington, D.C.*

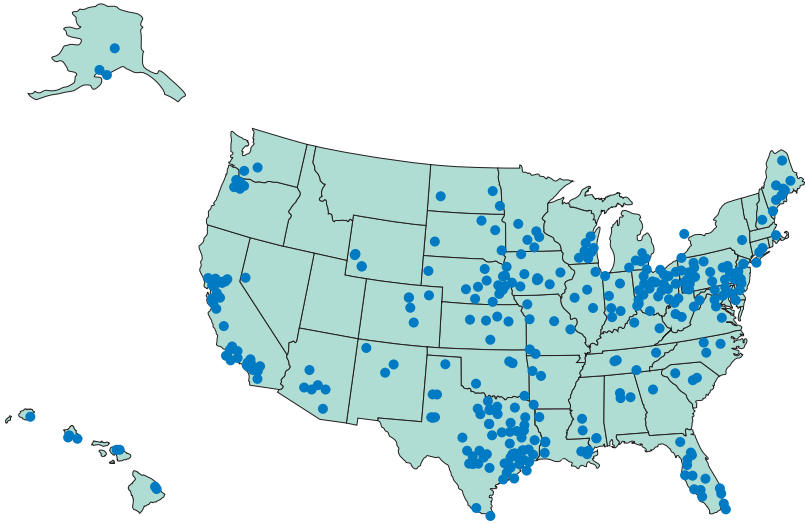

# MATHESON

ask...The Gas Professionals™

[www.mathesongas.com](http://www.mathesongas.com)

800-416-2505

Copyright 2015 Matheson Tri-Gas, Inc. All Rights Reserved.

All contents of this document are subject to change without notice and do not represent a commitment on the part of Matheson Tri-Gas, Inc. Every effort is made to ensure the accuracy of this information. However, due to differences in actual and ongoing operational processes and product improvements and revisions, Matheson Tri-Gas, Inc. cannot guarantee the accuracy of this material, nor can it accept responsibility for errors or omissions. This document is intended to serve as a general orientation and cannot be relied upon for a specific operation. No warranties of any nature are extended by the information contained in these copyrighted materials.

All names, products, and services mentioned herein are the trademarks or registered trademarks of their respective organizations and are the sole property of their respective owners. Matheson and the Matheson logo are registered trademarks of Matheson Tri-Gas, Inc.