



MATHESON
The Gas Professionals

Model 8067 Gas Leak Detector



Instrument User Manual

Declaration of conformity

Product description: a handheld micro thermal conductivity sensor used to detect gas leaks. This instrument has been designed specifically for search and location of non-flammable gases such as helium and CFC's.

Directives: 2004/108/EC

Electrical Equipment – Electromagnetic Compatibility (EMC)

Standards: BS EN 61010-1:2010

Safety requirements for electrical equipment for measurement, Control and laboratory use – Part 1: General requirements

BS EN ISO 9001:2008

Quality management systems – Requirements

BS EN 61326-1:2006

Electrical Equipment for measurement, control and laboratory use
- EMC Requirements (Class B and General Immunity)

Contents

Declaration of conformity	2
Statements	4
Safety	4
Quality Assurance	4
Responsibility of use	4
Disposal	4
Calibration Facility	4
Legal Notice	4
Instrument description	5
Packing List	6
How 8067 works	7
Thermal Conductivity	7
Instrument main menu	8
Functions	10
Contrast	10
Backlight	10
Sound	10
Peak hold	10
Calibration	10
Battery selection	11
View Data	11
Units	11
Display	11
Gas selection	12
The Keypad	13
Using The 8067	14
Probe options	15
Detecting Leaks	16
Calibration	17
Over view	16
Selecting Factory or Custom Calibration	17
Calibration procedure using 'ppm' units	17
Calibration procedure using 'cc/sec' units	18
Instrument warranty and service	19
Replacing batteries	19
Instrument Specifications	20
Replacing parts	21

Statements

Safety

Please read this manual in full before using the 8067 instrument. MATHESON takes no responsibility for damage, injury or death resulting from misuse, misunderstanding or negligence while using this gas detector. Please contact MATHESON via the address below for clarification on any aspect of this manual that is not understood or for additional information required.

This instrument should only be used by qualified or competent persons with suitable knowledge of the hazards relating to the gases contained within equipment or in the local environment.

Quality Assurance

8067 instruments are manufactured in compliance with ISO9001, which ensures that the equipment supplied to the customer has been designed and assembled reproducibly from traceable components, calibrated to traceable standards.

Responsibility of use

Many gases are hazardous and can cause explosion, poisoning and corrosion resulting in damage to property and life. It is the responsibility of the person using this instrument to ensure it is being used in accordance with this manual and that the instrument is functioning correctly before use.

The 8067 can detect a large range of gases but some gases are more difficult to detect.

It is the responsibility of the user to ensure the 8067 instrument has the sensitivity to detect the required gas before reaching potentially dangerous levels.

Inadequate performance of the gas detection equipment described in this manual may not necessarily be self-evident and consequently equipment must be regularly inspected and maintained. MATHESON recommends that personnel responsible for equipment use institute a regime of regular checks to ensure it performs within calibration limits and that a record be maintained which logs calibration check data. The equipment should be used in accordance with this manual, and in compliance with local safety standards.

Disposal

Disposal of the 8067, its components, and any used batteries shall be in accordance with local and national safety and environmental requirements. This includes the European WEEE (Waste Electrical and Electronic Equipment) directive.

Calibration Facility

MATHESON offers a calibration service including the issue of certification confirming calibration to NIST standards.

An 8067 Calibration Kit offers a means of checking and calibrating the instruments against a known reference, however MATHESON strongly recommend the instrument is returned to an approved service center on an annual basis for general maintenance and calibration.

Legal Notice

While every attempt is made to ensure the accuracy of the information contained in this manual, MATHESON accepts no liability for errors or omissions, or any consequences deriving from the use of information contained herein. It is provided "as is" and without any representation, term, condition or warranty of any kind, either expressed or implied. To the extent permitted by law, MATHESON shall not be liable to any person or entity for any loss or damage which may arise from the use of this manual. We reserve the right at any time and without any notice to remove, amend or vary any of the content which appears herein.

Instrument description

The 8067 is a portable hand held gas detector instrument predominantly used for detecting gas leaks, and can detect almost all gases to varying degrees. Being a hand held instrument, it is powered by standard AA size batteries and will accept both Alkaline and Nickel Metal Hydride (rechargeable) types.

The 8067 uses thermal conductivity as its means of detecting gas, which offers a robust sensor technology that requires practically no maintenance beyond annual servicing.

All 8067 models have an easy to use graphical interface with an intuitive keypad allowing simple function selection and adjustment.

The 8067 can be upgraded to add features without the need to be returned to the supplier and without having to modify the internal firmware.

8067 has an LCD display, LED indicator, and an audible buzzer that indicates the detected signal.

Common applications where the 8067 is already used include:

- * Quality assurance - Testing seal integrity after product manufacture
- * Laboratory applications - Detection of leaks from mass spectrometers and chromatograph equipment
- * Industrial - Leaks from gas cylinders, pipe work and process equipment
- * Medical - Testing of membrane materials and sealing of glove boxes
- * Pneumatic - Valve seal testing

The 8067 is calibrated against a 5 E-4 cc/s Helium leak to allow volumetric readings and also a 5000ppm Helium to allow measurement of concentrations.

Selectable units:

cc/sec	Cubic Centimetres per Second offers a reading that indicates the volume of gas escaping into atmosphere from a single point, i.e., leakage from a hole in a gas filled vessel or pipe.
ppm	Parts Per Million is a concentration reading, 8067 will display the concentration being detected however it is more difficult to gauge the quantity of leakage.
mg/m ³	Milligrams per meter cubed is also a unit that measures concentration. (See ppm above)
g/yr	Grams per Year is an alternative measure of leak rate.

IMPORTANT NOTES:

The 8067 is NOT intrinsically safe, so it should not be using in a potentially explosive environment. Intrinsically safe instruments are available. Please contact MATHESON for more information.

Ambient air pressure, heat and humidity can also affect readings.

The 8067 range is NOT 'Gas Specific' i.e. It can NOT differentiate between gases.

Packing list

Please remove all packing material and then check the content of the carry case against the list below before use. Should the instrument or any accessory appear damaged or missing then contact the instrument supplier for advice before use.

Item	Qty	Description	Check
1	1	8067 instrument with short probe and nozzle fitted	
2	1	Long probe	
3	1	Box spanner used to change probes	
4	1	Spare battery clip	
5	1	User Quick Start-up manual	



How the 8067 works

Thermal Conductivity

All gases conduct heat but by varying amounts, if an object is heated and then the source of heat is removed, the object will eventually cool down to match ambient air temperature. This action occurs because the ambient air surrounding the object carries the excess heat into the surrounding atmosphere.

This principle is also the same for objects that are cooler than the surrounding ambient air.

Dissipation of heat into an air atmosphere is known and is a predictable rate. However, if the ambient air is replaced with an alternative gas like Helium, the rate at which an object cools down changes.

If the object mentioned above had its environment replaced with pure Helium it would cool down to the environment temperature about 6 times faster.

The 8067 contains a heated thermistor bead that transmits heat to a block of material that remains at a constant temperature. As air passes through the detector chamber a constant amount of heat passes from the bead to the block. Gases that are different to air will affect the rate at which heat transmits from the bead to the block. These rates of change are measured and displayed as leak rates.

The diagram below shows the basic functionality of the 8067 Thermal Conductivity sensor.

A fan draws a small flow of gas through the probe and into the sensing chamber. The thermistor bead heats up when electrical power is applied. As air passes through the cell a constant level of heat is transmitted to a Temperature Stable block through the air, this rate of heat transmission is used to 'Zero' the instrument.

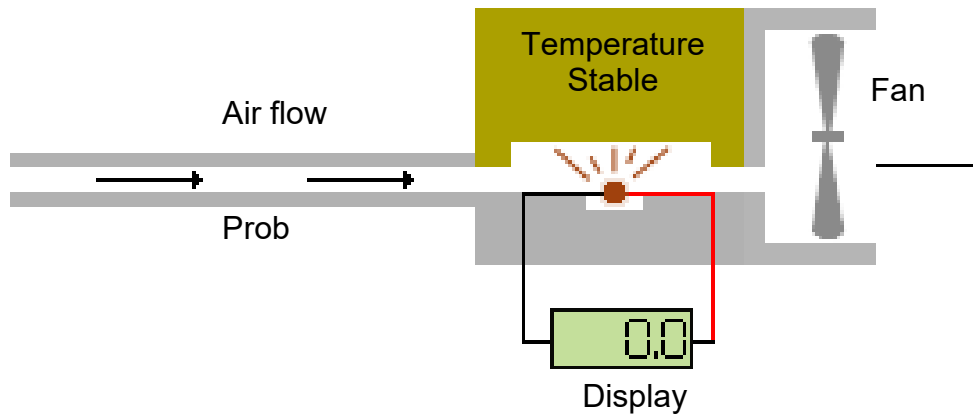

When gases with different thermal qualities pass through the chamber, the amount of heat being transmitted to the Temperature Stable block changes. These changes are measured, calculated and displayed on 8067 as leak rates or gas concentrations.

PLEASE NOTE:

- * Some gases have similar thermal properties to that of air; therefore the 8067 can only detect larger concentrations of these gases.
- * Some gases have positive and other gases negative signals. To simplify the instruments function 8067 only displays changes as positive readings.
- * The 8067 can NOT differentiate between gases! Selecting a specific gas on the 8067 allows the instrument to calculate concentrations of that gas only if that gas is being detected.

Instrument main menu

Once the 8067 has run through its 'Start up' routine, it will display its normal 'Running screen' used when locating gas leaks. Before using the instrument the various settings should be set and adjusted to suit the application.

Pressing the 'Esc' key while viewing this 'Running screen' will access the instruments Main Menu. Repeated pressing of the 'Esc' returns the display back to the 'Running screen'.



Running screen

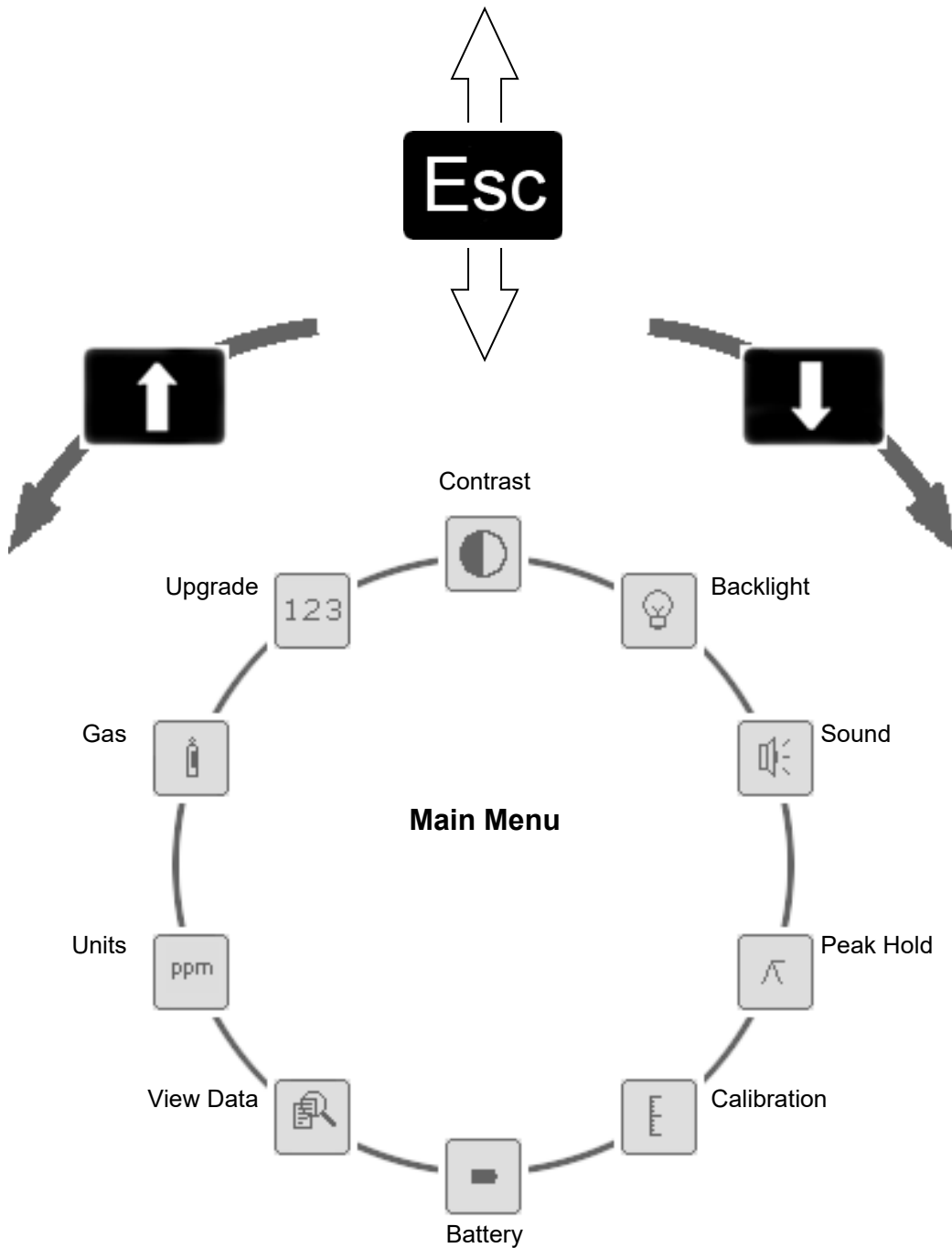

Running screen

8067 displays the 'Running screen' whenever the instrument is being used to detect leaking gas. The illustration below outlines the various information and icons.

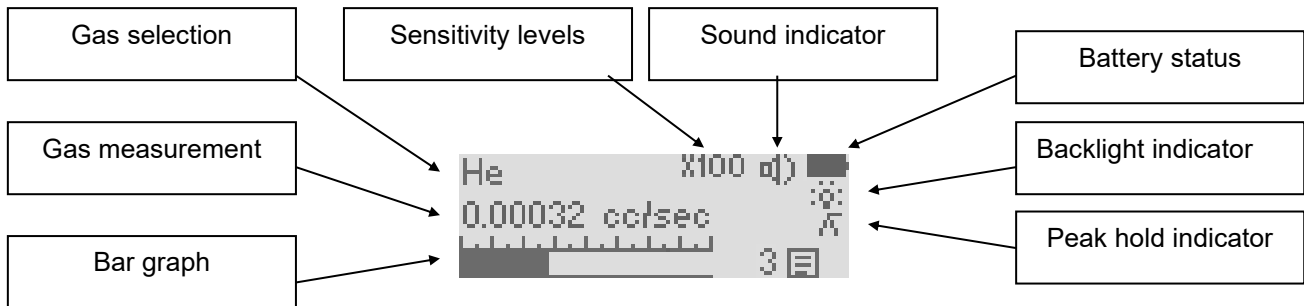

Gas selection

The 8067 displays the gas being measured in the top left of the running screen. The 8067 will display the gas selected at the factory only, however the 8067 model has a range of gases that can be selected via an internal gas table.

Sensitivity

The 8067 has three (3) sensitivity levels, X100 (times one hundred) is most sensitive, X10 (times ten) is mid-range and X1 (times one) is least sensitive. See the sensitivity of various gases on the table under 'Functions (continues), Gas Selection'.

Battery status

When the battery symbol is filled in the battery is full, when just an outline the battery is exhausted

Backlight

The backlight symbol shows the status of the backlight even in bright daylight.

Gas measurement

The 8067 measures the leak rate of gas leakage in which ever units are selected.

Sound indication

This symbol shows if the sounder is on or off. If the semi-circle (on the right) of the symbol is present then the sound is switched on; if not the sounder is switched off. The beep that occurs with each key press cannot be switched off.

Bar graph

The bar graph increases as gas is detected. This graph is not scaled and should be used for indication only.

Peak hold

When selected, peak hold displays the maximum measurement on the display. Pressing the ENTER key resets the reading but also logs the peak reading in memory.

Functions

The 8067 instruments have a variation of functionality,

Contrast



Use this function to adjust the contrast of the 8067 LCD (Liquid Crystal Display). Significant variations in ambient temperature conditions can cause the display to appear too dark or feint.

When this function is selected a number will appear to the right of the Contrast symbol as a percentage. Use the Up and Down keys to adjust the display contrast to the desired level. When satisfied with the desired level selected, press the Esc key to exit to the main menu.

Backlight



The user can select either Backlight On or Backlight Off.

In daylight the user may not be able to determine if the backlight is On or Off, therefore a symbol on the main running screen shows the status.

When the backlight is 'ON' it significantly reduces battery life.
Backlight OFF = 40hrs of use, Backlight ON = 20hrs of use.

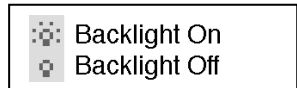

Sound



The 8067 has an audible sounder that increases frequency as detected gas levels increase. This sounder can be switched On and Off. Use the Up or Down key to move the 'tick' to the desired position and then press the 'Esc' key to return to the Main Menu.

An audible 'beep' can also be heard whenever the key pad is pressed, this beep cannot be switched off.

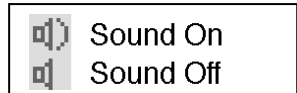

Peak hold



When selected, this function holds the highest detected reading on the display until the 'ENTER' key is pressed.

Select Peak On or Off using the 'Up or Down' key and then press 'Esc' key to exit to the 'Main menu'.

When using the 8067, press the ENTER key to clear the held reading.

The reading held on screen will be logged when the 'ENTER' key is pressed.

WARNING: ZEROing the instrument in a contaminated environment will result in false readings.

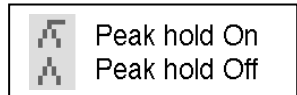

Calibration



There are two Calibration settings that can be selected; Factory and Custom. Factory calibration is carried out shortly after manufacture and cannot be adjusted, however Custom calibration offers the ability to calibrate the instrument between annual Factory calibrations. The 8067 Zero's its reading at switch on, therefore the Custom calibration routine only has one stage.

Also see the 'Calibration' section of this manual.

2 & 3

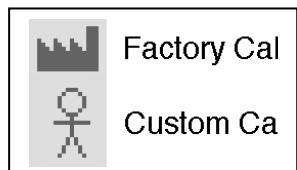

Functions

Battery selection

3



The 8067 will operate using AA size batteries in either Alkaline (non-rechargeable) or Nickel Metal Hydride (Rechargeable).

Select the battery type using the 'Up or Down' key and then press the 'Esc' key to exit to the Main menu.

Failing to select the correct battery type will not damage the instrument or affect its ability to detect gas, however it will cause the battery indicator to read incorrectly.

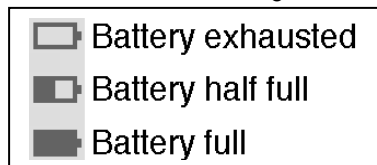

View Data

3

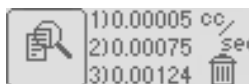

The 8067 instrument has the ability to data log 10 readings within its internal memory. To store a reading press the 'ENTER' key while on the main Running screen. When readings are stored in memory a symbol will appear on the Main viewing screen.

When the memory is full the 'Data' symbol will flash. The stored data can be viewed by scrolling through the logged readings using the 'Up and Down' keys. To delete the stored data press and hold the 'ENTER' key, the 'Trash can' symbol will flash, continue holding the 'ENTER' key until the data is deleted. Press the 'Esc' key to exit to the Main menu.



Units

3

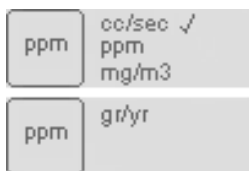

8067 instruments have the capability of displaying detected readings in a variation of units; ppm, cc/s, mg/m³ and g/yr.

Use the 'Up and Down' keys to select the desired unit and then press the 'Esc' key to exit to the main menu.

Please note: *the Custom Calibration routine automatically selects the type a calibration depending on this setting. See the 'Calibration' section of this manual.*

cc/sec = Cubic Centimetres per second offers a volumetric leak rate that directly measures the volume of a gas escaping from a given point, it is also known as ml/sec (Millilitres per second). The GasCheck can typically detect Helium leaks down to 0.0005 of a cubic centimetre per second.

ppm = Parts per million, this unit indicates a concentration but can't be used to quantify a volume of gas leakage.

mg/m³ = Milligrams per meter cubed, like ppm this unit is also concentration so can't be used to quantify a volume of gas leakage.

g/yr = Grams per year offers an alternative volumetric leak rate that directly measures the volume of a gas escaping from a given point.

Display

3



8067 instruments have the capability of displaying cc/sec and g/yr readings in either decimal or exponent form. (Readings in ppm and mg/m³ can only be displayed in decimal form.)

Use the 'Up and Down' keys to select the desired unit. Press the 'Enter' key to display the next screen. Use the 'Up and Down' keys to select the desired display and then press the 'Esc' key twice to exit to the main menu.

Functions

Gas selection

3



He ✓

8067 is calibrated using Helium gas at time of manufacture, however other gases can be detected and measured using a gas table within the instrument.

Although 8067 can't differentiate between gases it can quantify other gases using response factors stored in its internal gas table. Gas groups 0, 1 2, 3, and 4 offer a generic sensitivity.

The following list indicates response factors for specific gases; however for advice on gases not listed please contact MATHESON for advice.

Name	Abbreviation	Minimum sensitivity cc/sec (ml/sec)	Minimum sensitivity cc/sec (ml/sec)
Hydrogen	H2	7.7 E-6 cc/sec	0.0000077 cc/sec
Helium	He	1.0 E-5 cc/sec	0.000010 cc/sec
Refrigerant R12	R12	2.7 E-5 cc/sec	0.000027 cc/sec
Refrigerant R1301	R1301	2.4 E-5 cc/sec	0.000024 cc/sec
Refrigerant R134a	R134a	5.8 E-5 cc/sec	0.000058 cc/sec
Refrigerant R22	R22	2.6 E-5 cc/sec	0.000026 cc/sec
Refrigerant R11	R11	3.2 E-5 cc/sec	0.000032 cc/sec
Sulphur Hexafluoride	SF6	2.2 E-5 cc/sec	0.000022 cc/sec
Carbon Dioxide	CO2	4.0 E-5 cc/sec	0.000040 cc/sec
Methane	CH4	2.9 E-5 cc/sec	0.000029 cc/sec
Argon	Ar	3.5 E-5 cc/sec	0.000035 cc/sec
Oxygen	O2	2.9 E-4 cc/sec	0.000290 cc/sec
Refrigerant R502	R502	3.0 E-5 cc/sec	0.000030 cc/sec
Refrigerant R404a	R404a	3.2 E-5 cc/sec	0.000032 cc/sec
Refrigerant R407c	R407c	3.3 E-5 cc/sec	0.000033 cc/sec
Refrigerant R410a	R410a	3.2 E-5 cc/sec	0.000032 cc/sec
Refrigerant R507	R507	3.8 E-5 cc/sec	0.000038 cc/sec

To select an alternative gas use the 'Up and Down' keys to select the desired gas and then press the 'ENTER' key to confirm the selection, at which point a tick will appear. Press the 'ENTER or Esc' key to exit into the 'Main menu'.

If the gas to be detected does not appear in the instruments internal gas table then one of the five 'Gas Groups' can be selected. 'Gas Groups' have a variation of sensitivities. (Group 1 being high sensitivity through to Group 5 being low sensitivity) Contact MATHESON for advice.

Gas groups allow the instrument to calculate leak rates with reasonable accuracy.

Getting started

The Keypad

All 8067 models have the same keypads, the following section explains the general functionality of each key:-

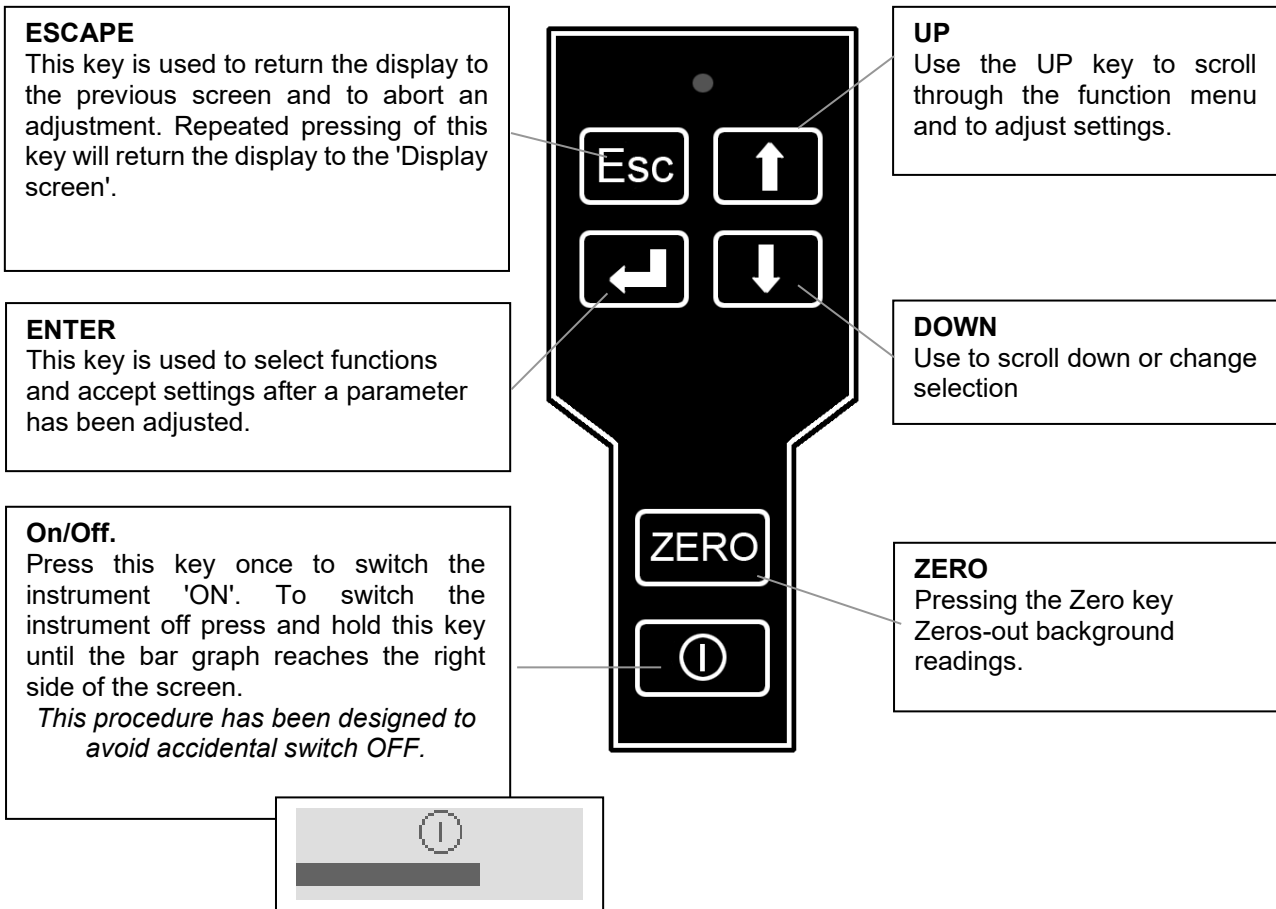

When the 8067 first switches on it will display its model number and the Gas that it has been calibrated with.

8067
He

A screen appears to indicate the 8067 is Zeroing it's signal.

Zeroing...



Once the Zero routine is complete the instrument displays it's running screen and is ready for use.

Using the 8067

The 8067 instrument

WARNING: Before switching the 8067 on, ensure the ambient air is clean as the instrument automatically Zero's the sensor at switch on. After the instrument has run through its start up routine, adjust the instrument settings to the desired levels. Check the instruments sensitivity using a calibration kit.

Switch the 8067 on by pressing the ON/OFF key, after the instrument has completed its Zero routine it will enter its normal running screen. (see right)



Ensure the instrument is on the X100 (times one hundred) range, while on the main running screen use the UP and DOWN key to adjust between sensitivity ranges. X100 is most sensitive, X1 is the least sensitive.

Gas leaks tend to occur at pneumatic joints or welded seams, hold the 8067 at a 45° angle to the object being tested and drag the probe along the seam or joint at a rate of approximately 25mm per second. When a leak is detected the bar graph will start to fill and the frequency of the audio output will increase but will reduce as the probe moves away from the leak. Return the probe to the suspected leaking area and move slowly along the same area until the leak is located, once located the probe should be held at the leak until the numeric reading stabilizes.

The bar graph offers a graphical indication only and should not be used to measure a leak. You may find that the graph completely fills, however the numeric reading will continue to increase. Should the instrument detect a leak that is too large for the range selected the numeric screen will flash and display '99999'. Use the UP or DOWN keys to adjust the instrument sensitivity.

Variation in temperature, humidity and background gas may result in a constant level being detected on the instrument. To reset to Zero, hold the instrument away from the source of contamination and then press the ZERO key. The instruments display will return to a near zero reading.

The following things will affect the instruments reading:-

- * Breath of the instrument user contains both CO₂ and moisture;
- * Barometric air pressure and background temperature;
- * Sources of cold and heat.

Probe options

In some applications the grey probe cover may restrict access to the area under test, the grey probe cover can be removed by pulling it off way from the instrument ❶. When the grey cover is removed great care should be taken when using the instrument and the following precautions noted:-

- * Do not remove the semi-transparent probe sleeve, this sleeve ensures the metal inner probe remains 1 mm from the surface of the test area avoiding accidental dirt and moisture ingress.
- * Do not touch the probe and especially the brass sensor housing. Heat from fingers can result in significant changes in signal causing false readings.
- * Avoid placing the probe on wet or dirty surfaces, blockage of the probe will result in instrument failure.

Some application may require a longer probe to gain access to pneumatic joints and seams to be tested. The 8067 is also supplied with a 300mm probe that can be changed by the user. To change probes carefully follow the following steps:-

- * Switch the instrument OFF
- * Remove the outer grey probe cover ❶
- * Place the box spanner (supplied with the instrument) over the existing probe so the spanner fits over the brass nut ❷, unscrew the probe counterclockwise direction. ❸
- * Withdraw the spanner and probe assembly ❹

To refit the short or the long probe follow the steps above but in reverse order.

CAUTION: When using the box spanner to tighten the probe nut, ensure the nut is firmly tightened however do not use additional tools as the tread may become damaged.

Should a probe become blocked, use dry, clean compressed air to blow out the blockage from the instrument end of the probe.

Cautionary Note: The instrument has been factory calibrated using the standard short capillary which sets a certain flow rate into the detector.

The long capillary by nature of its construction has a different flow to improve the time response in detection. This will change the calibration of the instrument when the long probe is used instead of the short capillary. Thus the long probe is only to be used in finding leaks in difficult places where the standard short probe cannot reach. The readings given by the long probe are only qualitative and the reading given by the display is only to be taken as being relative to another value given by another leak site while using the long probe.

WARNING: Ensure safety guidelines are adhered to when using compressed air.
(MATHESON takes no responsibility for injury or damage caused by misuse of compressed air equipment)

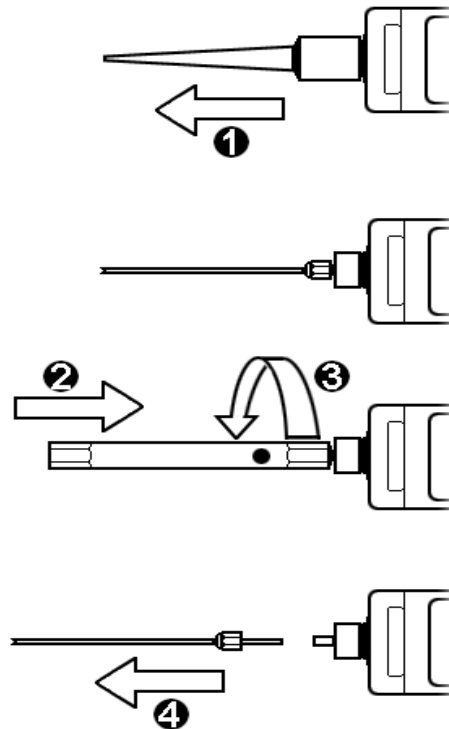

Detecting leaks

Overview

Hold the 8067 in one hand and draw the instrument probe along the area to be checked at approximately 25mm per second. When a leak is detected retrace the route of the probe at a slower rate until the leak is located. Once located, hold the instrument over the leak until the measurement stabilises. The reading can be logged by pressing the ENTER key.

Some readings may be larger than the instrument can detect and the measurement units will be replaced by '99999' on the display, in which case use the UP or DOWN keys to adjust the instrument's sensitivity.

When detecting very small leaks or when detecting gasses less sensitive, then a rate of 10 mm per second may be required.

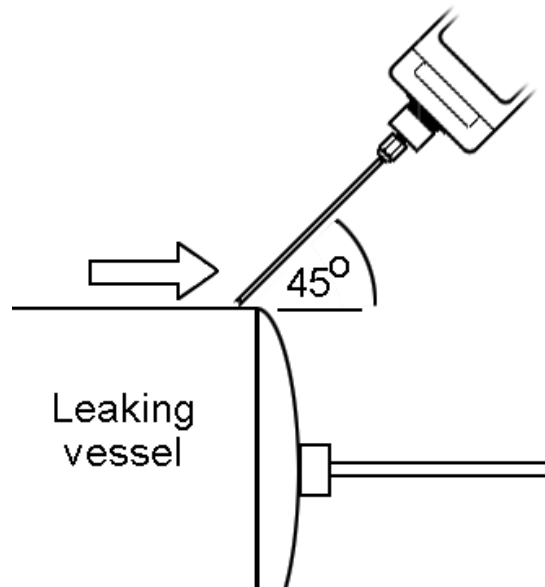

The outer grey probe cover can be removed to allow better access to restricted areas, if the outer probe is removed the following points should be noted:-

- * Avoid bending the inner probe as this will affect the 8067 accuracy.
- * Avoid placing the probe in liquid or dirt as the probe can become blocked.
- * Care should also be taken to ensure the brass sensor housing component remains at a constant temperature. Avoid touching the brass sensor block with fingers.
- * The 8067 can detect changes in Humidity and Carbon dioxide, therefore avoid breathing on the probe.
- * The thin white tube that covers the inner probe should not be removed. This tube ensures a 1mm gap is maintained between the probe and the surface being tested.

Calibration

Over view

The 8067 has two selectable calibration settings; Factory and Custom. 'Factory Calibration' done during the instruments manufacture, it can be selected and used but cannot be changed.

The 8067 is calibrated against a 5000 ppm Helium concentration and a 0.0005cc/sec (5 E-4) Helium leak rate. 'Custom Calibration' gives the user the ability to calibrate the instrument. This facility may offer improved accuracy over the 'Factory Calibration' if the Barometric air pressure differs from that stated on the instruments Calibration certificate.

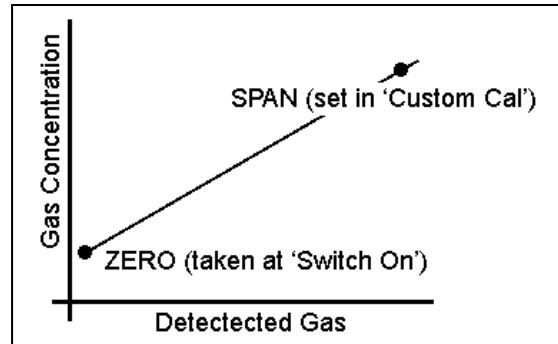

Selecting Factory or Custom Calibration

To select either Factory or Custom Calibration select the Calibration screen and use the UP and DOWN keys to move the 'tick / check' under the desired symbol, then Press the 'Esc' key to exit into the main menu.

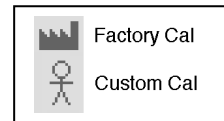

'Custom Calibration' can only be selected and used after the instrument has been calibrated by the user. To do this move the 'tick / check' under the 'Custom Cal' symbol and press the ENTER key.

The 8067 requires either 5000 ppm Helium concentration or a 0.0005cc/sec (5 E-4 cc/sec) leak rate as a reference. The 8067 automatically selects the type of Calibration media based on which units the instrument already has selected.

If the 8067 is used to detect leaks measured using 'ppm or mg/m³' units, then the instrument must be calibrated using a 5000 ppm Helium concentration.

If the 8067 is used to detect leaks measured using 'cc/sec' units, then the instrument must be calibrated using a 0.0005 cc/sec (5 E-4) Helium leak.

Calibration procedure using 'ppm' units

Please read this entire procedure before proceeding with this calibration routine.



* Fill an empty (uncontaminated) sample bag with 5000 ppm Helium gas before starting the calibration procedure. Also remove the outer grey probe from the 8067.

* Select the 'Custom Cal' symbol from the instruments menu. An option appears allowing the adjustment of the 'ppm' value to ensure the instrument matches the gas concentration being used. Use the UP and DOWN keys to adjust between 4900 and 5100 ppm.

* Ensure the instrument is in clean air and then press the ENTER key, the instrument will Zero, this will take a few seconds but once complete a 'Ready' message will appear.

* Insert the instruments probe fully into the sample bag containing the gas and press the ENTER key. The instrument will automatically sequence through the cold and hot stages of calibration but when finished gives a summary of values.

* Press the ENTER key to return back to the calibration option screen. Press the ESC key to start using the instrument or press the ENTER key to calibrate again.

NOTE: To avoid errors in calibration the following points should be noted:-

* Avoid bending the inner probe as this will affect the 8067 accuracy.

* 8067 can detect changes in Humidity and Carbon dioxide, therefore avoid breathing on the probe.

* Avoid pressurizing the sample bag as this will cause significant errors in reading

Calibration

Calibration procedure using 'cc/sec' units

Please read this entire procedure before proceeding with this calibration routine.



* Follow the instructions of the calibration standard. The pointer of the pressure gauge must be resting over the green segment.

* Select the 'Custom Cal' symbol from the instrument's menu.

* Ensure the instrument is in clean air and then press the ENTER key, the instrument will Zero, this will take a few seconds but once complete a 'Ready' message will appear.

* Insert the instrument's probe into the standard outlet and press the ENTER key. The instrument will automatically sequence through the cold and hot stages of calibration but when finished gives a summary of values.

* Pressing the ENTER key will return back to the calibration option screen. Press the ESC key to start using the instrument or press the ENTER key to recalibrate again.

NOTE:

* 8067 can detect changes in Humidity and Carbon Dioxide, therefore avoid breathing on the probe.

WARNING: Great care should be taken to ensure the calibration gas is neither pressurised or restricts flow to the instruments probe. Changes in flow of gas to the sensor will result in significant errors in readings.

Instrument warranty and service

Warranty

Standard Warranty is one year from date of purchase.

Service

At MATHESON we recommend that all of our gas detection instruments be returned for service and factory calibration once every 12 months.

Contact MATHESON or your local distributor for service options in your area.

Replacing batteries

Before using the 8067 instrument ensure the batteries are fitted correctly or ensure NiMH (rechargeable) batteries are fully charged before use.

To fit or replace batteries you must first remove the battery cover from the rear of the instrument. This can be done by prising open the battery clip with a finger nail or screw driver.

Removing the battery holder will reveal a battery holder, which requires 4 x AA size batteries. Before removing old batteries or fitting new ones unclip the battery holder from the instrument by prising apart the PP3 type clip shown in the illustration.

Once the battery holder is disconnected from the instrument, the batteries can be removed or replaced however care must be taken when refitting the batteries to ensure they are the correct polarity, polarity markings are moulded on to the battery holder plastic.

The battery holder can be reconnected to the 8067 by firmly pressing the two halves of the PP3 clip together. Care should be taken to ensure the polarity is correct, see the PP3 diagram (right).

The battery pack is then laid within the instrument and the battery cover refitted, be careful not to trap wires when refitting the battery cover.

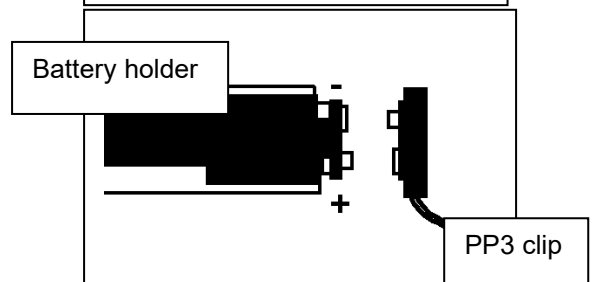
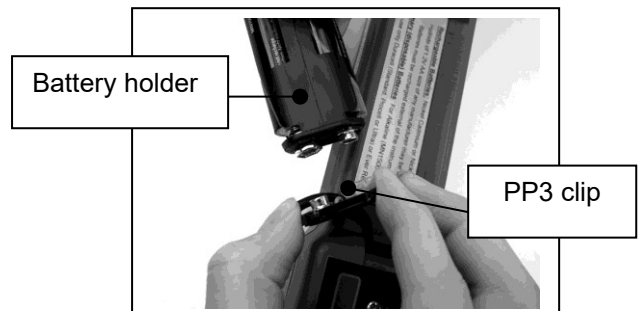
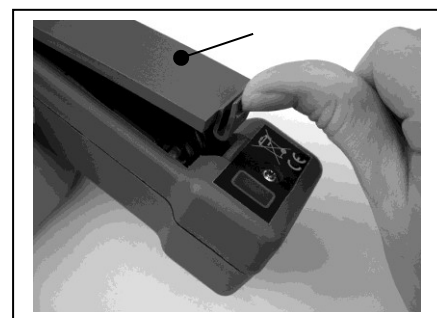

Instrument specifications

Operating temperature	0 to 50 °C	32 to 122 °F
Storage temperature	-25 to 70 °C	-13 to 158 °F
Instrument case	Polyurethane	
Dimensions	L.390 x W.60 x H.50 mm	L15.35" x W2.35" x 2.0 "
Weight	0.5 kg	1.0 lb.
Ingress ratings	IP20	
Length of long probe	300 mm	12"
Detection type	Thermal conductivity	
Detection time to T90	1 sec (Short probe)	9 sec (long probe)
Clear down time	1 sec (Short probe)	9 sec (long probe)
Battery type	Alkaline or NiMH AA (Qty 4)	
Battery life at 20 °C (68 °F).	40 Hours (20 hours when using the backlight)	

Replacing parts

Part	Item Number
Long probe	8067-LPR
Short probe	8067-SPR
Replacement battery holder 3000	8067-BATHDLR
Nozzle	8067-NOZ
Box Spanner	8067-SPNR



166 Keystone Drive
Montgomeryville, PA 18936
800-828-4313
www.mathesongas.com
INT-0313 rev B

Copyright 2021 Matheson Tri-Gas, Inc. All Rights Reserved.

All contents of this document are subject to change without notice and do not represent a commitment on the part of Matheson Tri-Gas, Inc. Every effort is made to ensure the accuracy of this information. However, due to differences in actual and ongoing operational processes and product improvements and revisions, Matheson Tri-Gas, Inc. cannot guarantee the accuracy of this material, nor can it accept responsibility for errors or omissions. This document is intended to serve as a general orientation and cannot be relied upon for a specific operation. No warranties of any nature are extended by the information contained in these copyrighted materials.

All names, products, and services mentioned herein are the trademarks or registered trademarks of their respective organizations and are the sole property of their respective owners. Matheson and the Matheson logo are registered trademarks of Matheson Tri-Gas, Inc.

TERMS AND CONDITIONS OF SALE
<https://shop.mathesongas.com/terms-and-conditions>